

MPX³ CTX³ RTX³

UNCOMPROMISING
PERFORMANCE
FOR MOTOR
PROTECTION
AND CONTROL



CATALOGUE
PAGES
→ INSIDE

THE GLOBAL SPECIALIST
IN ELECTRICAL AND DIGITAL BUILDING INFRASTRUCTURES

 **legrand**[®]



MPX³ CTX³ RTX³ A SENSE OF FAMILY

There are requirements for control and protection of motors in all sectors: heating, ventilation and air conditioning in commercial buildings; pumps, compressors, conveyors and machines in industrial buildings, etc. Legrand's new motor circuit breakers, contactors and thermal relays provide a response for all these applications. Their high performance levels, perfect complementarity, compact size, ease of mounting, wide range of auxiliaries, etc. make them suitable for installation in all distribution boards and control enclosures.



INDEX

2	A COMPLETE RANGE OF DEVICES FOR THE PROTECTION AND CONTROL OF MOTORS
4	MPX ³ : MAXIMUM EFFICIENCY IN A COMPACT UNIT
6	AUXILIARIES AND ACCESSORIES PROVIDING FLEXIBILITY
8	CTX ³ : CONTROL OF CIRCUITS
10	CTX ³ MINI: AN ULTRA-COMPACT SOLUTION
12	RTX ³ : THERMAL PROTECTION OF MOTORS
14	ACCESSORIES FOR ALL APPLICATIONS
16	CATALOGUE PAGES

A COMPLETE RANGE OF DEVICES FOR THE PROTECTION AND CONTROL OF MOTORS



MPX³ MOTOR PROTECTION CIRCUIT BREAKERS UP TO 100 A

- High breaking capacity and type 2 coordination for an optimum service level
- Trip class 10
- Sensitive to phase loss
- Compact
- Can be fixed on 35 mm DIN rail or using screws
- Easy combination with CTX³ 3-pole contactors
- Complete range of control and signalling auxiliaries and accessories

STANDARD
BREAKING
CAPACITY

HIGH BREAKING CAPACITY

MAGNETIC ONLY



MPX³ 32S
0.16 A - 100 kA
to 32 A - 15 kA



MPX³ 32H
0.16 A - 100 kA
to 32 A - 50 kA



MPX³ 63H
10 A - 100 kA
to 63 A - 50 kA



MPX³ 100H
17 A - 100 kA
to 100 A - 75 kA



MPX³ 32MA
0.16 A - 100 kA
to 32 A - 50 kA



CTX³ CONTACTORS AND RTX³ THERMAL RELAYS UP TO 800 A

- Compact
- High mechanical and electrical endurance for maximum reliability
- 3-pole and 4-pole contactors
- Screw terminals or cage terminals
- Complete range of auxiliaries and accessories
- Standard and differential version thermal relays

3-POLE CTX³ CONTACTORS

4-POLE CTX³ CONTACTORS



RTX³ thermal relays



MPX³: MAXIMUM EFFICIENCY IN A COMPACT UNIT

With just 4 sizes of unit, the MPX³ range of circuit breakers offers uncompromising performance levels and functions for the protection of motors up to 100 A.



1 IP 2X terminals



MPX³ 32 screw



MPX³ 63/100 cage

2 Front and side mounting of auxiliary contacts

3 Mount on  rail

4 Wide current adjustment range

5 Settings protected by a sealable transparent cover (optional)



6 Test function

7 Handle can be padlocked in OFF position



8 Label-holder



Certification

- EC declaration of conformity
- UL listed
- EAC



IEC 60947, UL 508
UL 508 Type E, K 60947, GB 14048

A COMPLETE RANGE UP TO 100 A IN 4 SIZES



> 45 mm <
MPX³ 32S



> 45 mm <
MPX³ 32H/MA



> 55 mm <
MPX³ 63H



> 70 mm <
MPX³ 100H

BREAKING CAPACITIES ICU AT 415 V~

MPX³ 32S

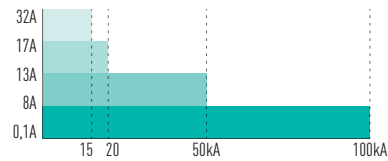

MPX³ 32H/MA

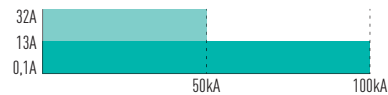

MPX³ 63H

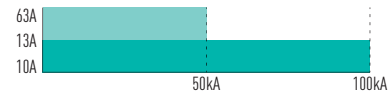

MPX³ 100H



PERFECT COMPLEMENTARITY WITH CTX³ CONTACTORS

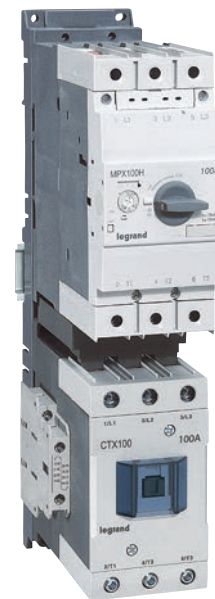

Using the dedicated accessories, MPX³ motor circuit breakers and CTX³ contactors can be joined together directly to create compact motor starters.

AUXILIARIES AND ACCESSORIES PROVIDING FLEXIBILITY

Whatever the specifications of your installation, you will always find a solution from the wide range of dedicated auxiliaries and accessories for MPX³ circuit breakers.



ELECTRICAL AUXILIARIES COMMON TO ALL SIZES OF MPX³

- ① Front-mounting auxiliary contacts



- ② Side-mounting auxiliary contacts and fault signal contacts

- ③ Side-mounting shunt trips and undervoltage releases



Possible combinations of auxiliaries

AUXILIARIES			MPX ³ 32S		MPX ³ 32H/MA		MPX ³ 63H		MPX ³ 100H		
AUXILIARY CONTACTS	FRONT-MOUNTING	MAX. NO.	0	1 or	0	1 or	0	1 or	1	0 or	1
	SIDE-MOUNTING	MAX. NO.	2	1	2	1	2	1	0	2	1
FAULT SIGNAL CONTACT		MAX. NO.	0	1	0	1	0	1 ⁽¹⁾	1 ⁽²⁾	0	1 ⁽²⁾
SHUNT TRIP OR UNDERVOLTAGE RELEASE		MAX. NO.	1	1	1	1	1	1	1	1	1

⁽¹⁾: Cat. No. 4 174 07 - ⁽²⁾: Cat. No. 4 174 08

A COMPLETE RANGE OF DEDICATED ACCESSORIES FOR EASIER INSTALLATION

Supply busbars and terminals for connecting the circuit breakers in parallel.

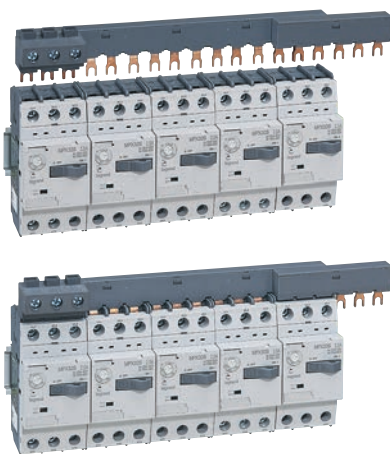

Remote rotary control for mounting on door and IP65 unit with black or yellow and red rotary handle.



Plates and connectors for creating motor starters.

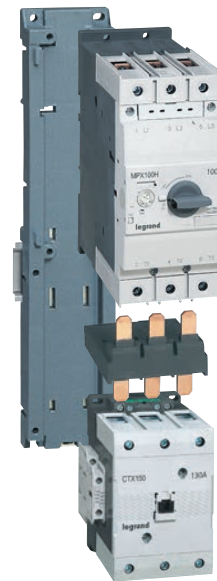

CTX³: CONTROL OF CIRCUITS UP TO 800⁽¹⁾ A

With a comprehensive selection of ratings, control voltages, auxiliaries and accessories, and total complementarity with MPX³ circuit breakers and RTX³ thermal relays, CTX³ power contactors provide an ideal solution for motor switching and controlling circuits for the most demanding applications.

⁽¹⁾ 900 A for 4P contactors

CTX³ 225/400/800: MOUNTING ON PLATE UP TO 800 A

- 1 Connection plates for bars or lugs
- 2 Pre-mounted auxiliary contact blocks (2 per contactor). Additional auxiliary contact blocks can be mounted on the right or left of the contactors.

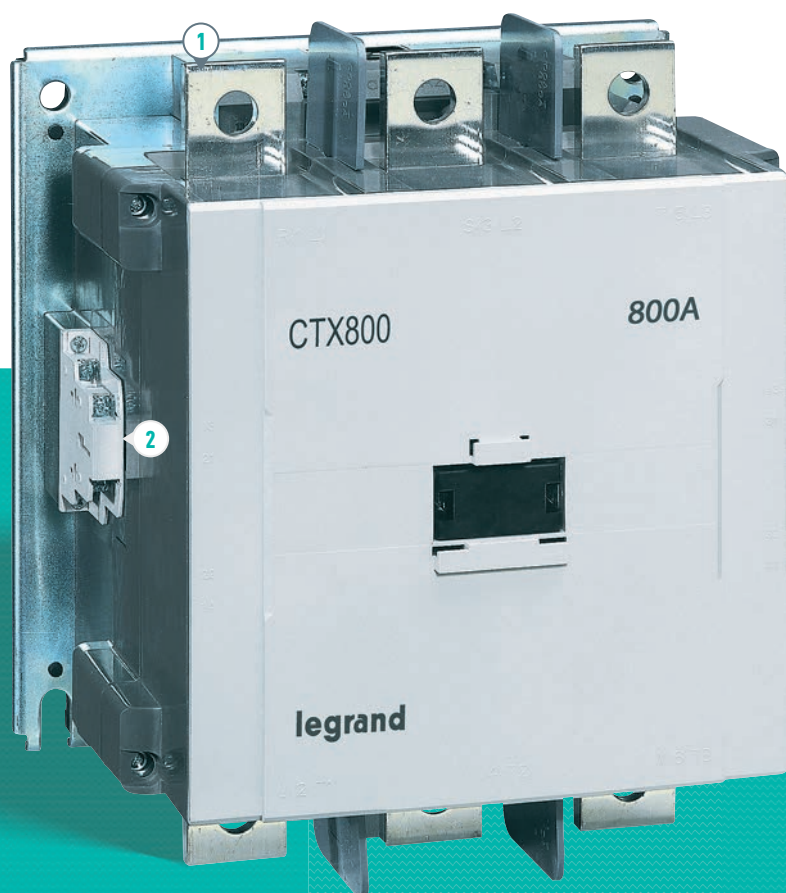



The 4-pole version of CTX³ contactors is available from 20 to 900 A (AC-1).

CTX³ 22/40/65/100/150: MOUNTING ON DIN RAIL OR ON PLATE UP TO 150 A

- 3 IP 2X terminals: screw terminals up to 40 A, screw or cage terminals from 50 to 150 A
- 4 Integrated auxiliary contacts
- 5 A1 and A2 supply terminal block (top and bottom)



Common time-delay modules and auxiliary contact blocks for all CTX³ up 150 A.

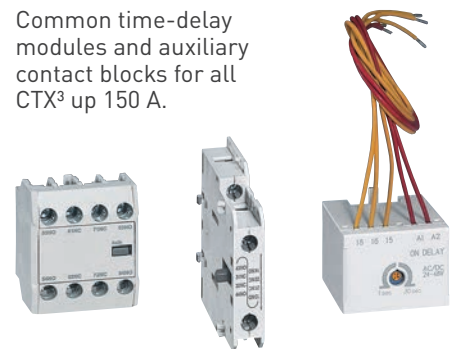

CTX³ contactors can be fitted with a safety cover.

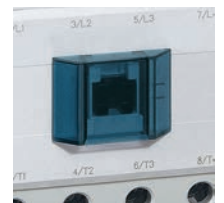

CTX³ MINI: AN ULTRA-COMPACT SOLUTION UP TO 16 A

With their compact size, CTX³ MINI are easy to integrate in control panels or distribution boards for switching motors, lighting and heating circuits up to 16 A.



CTX³ MINI: MOUNTING ON DIN RAIL OR ON PLATE

- ① IP 2X screw terminals
- ② Integrated auxiliary contact (3P only)
- ③ A1 and A2 supply terminal block

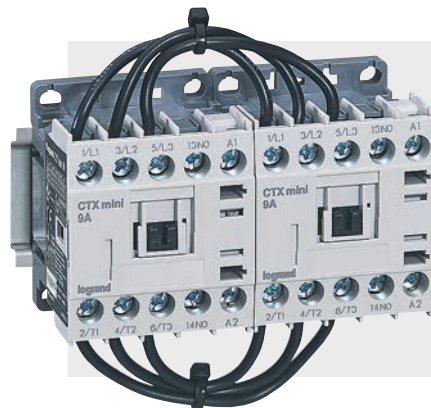

The flexible wire kits allow to associate freely two CTX³ mini 3-pole contactors and make very compact assemblies for motor reversing. For motors up to 7.5 kW 415 V.

AUXILIARIES AND ACCESSORIES FOR EVEN MORE APPLICATIONS

CTX³ mini contactors can take front and side-mounting additional auxiliary contact blocks and a mechanical interlock module.



CTX³ control relays take the same auxiliaries as the CTX³ mini.



Plate and connector for joining a CTX³ mini and an MPX³ 32 motor circuit breaker together directly to create a compact motor starter.

RTX³: THERMAL PROTECTION OF MOTORS

RTX³ thermal relays provide protection against overloads, long starting times and prolonged stalling of the motor. The differential technology provides increased protection in the event of the failure of one phase. They are very easy to install, connecting directly beneath CTX³ contactors.

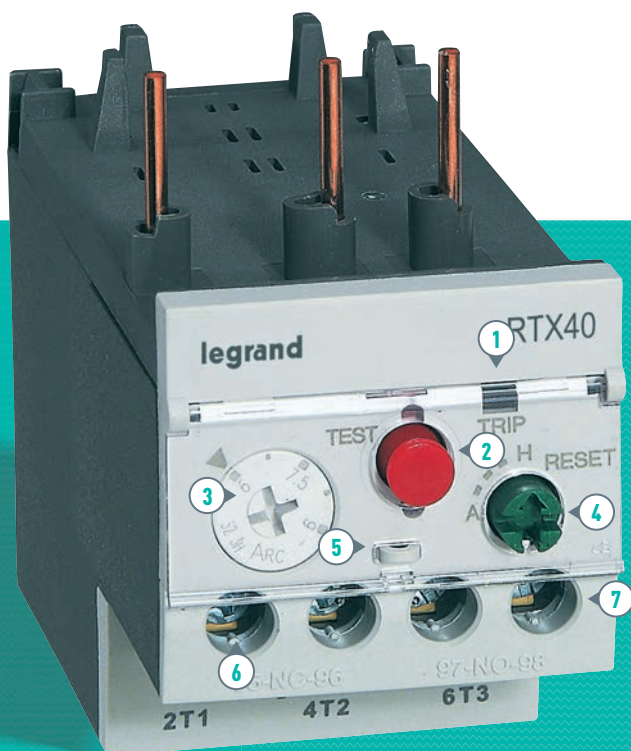

- 1 Trip indicator
- 2 Off/test button
- 3 Adjustment of the trip threshold of the thermal protection
- 4 Reset button and mode selector switch: automatic (A)/manual (H)
- 5 Sealable protective cover
- 6 Integrated auxiliary contacts (1 NO + 1 NC)
- 7 IP20 terminals

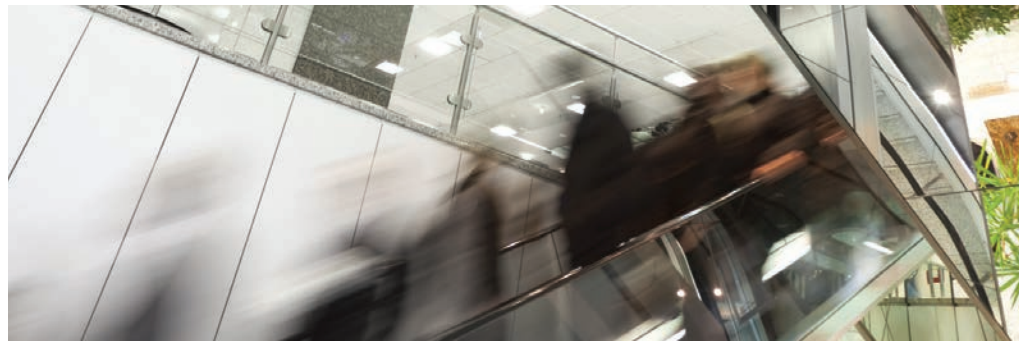

COMPACT MOTOR STARTERS



Mounting directly beneath contactors or separately (up 150 A) with the dedicated accessory.

A COMPLETE RANGE

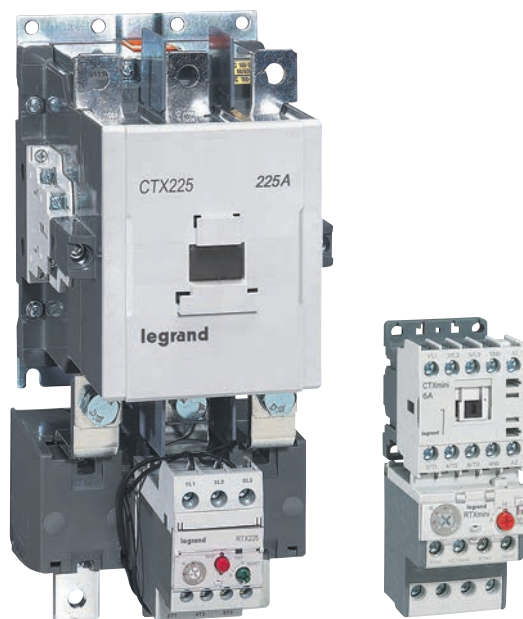

RTX³ thermal relays can be used to create 0.1 A to 800 A motor starters when combined with contactors, from the CTX³ mini to the CTX³ 800.

ACCESSORIES FOR ALL APPLICATIONS

With the wide range of accessories, CTX³ contactors can be used in a wide variety of applications:

- Switching capacitor banks
- Supply inverter
- Reversing contactor
- Time-delay motor starter
- Control unit on machine, etc.

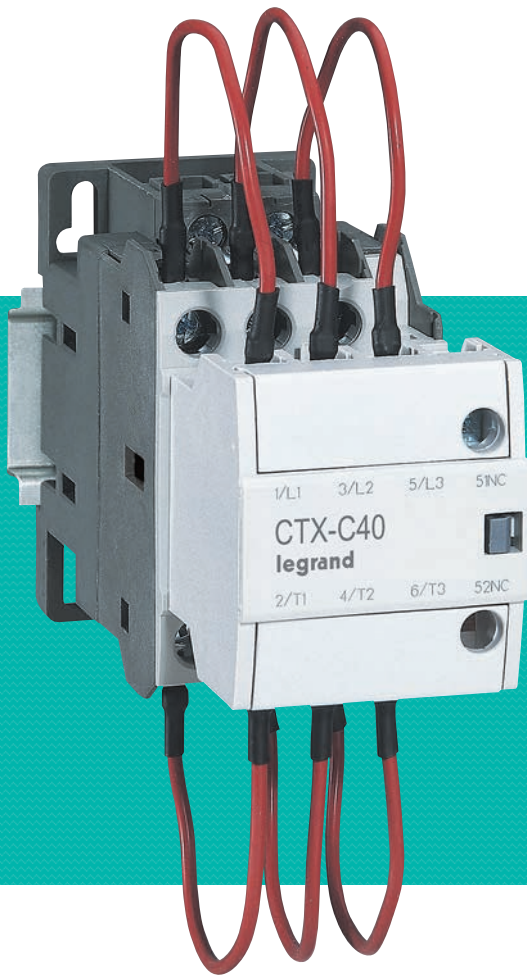

FRONT-MOUNTING BLOCK FOR SWITCHING CAPACITORS

Auxiliary blocks for switching capacitors are installed directly on CTX³ 3-pole, 9 to 100 A contactors. With their discharge resistors, they reduce current peaks during switching of capacitor banks.



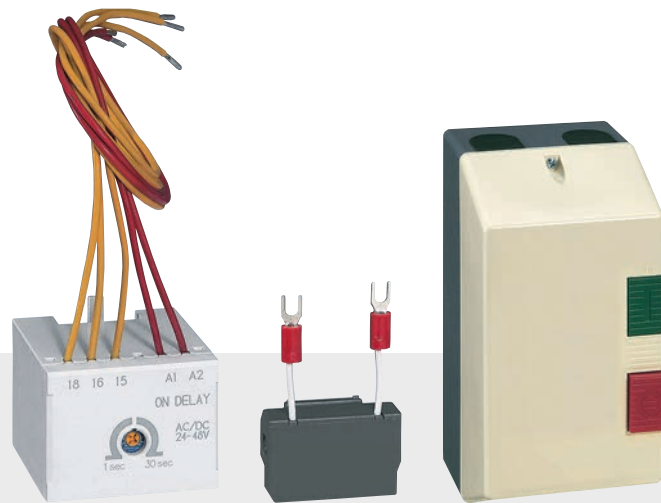

Time-delay modules, interference suppression module, motor starter units, etc., a complete range of accessories for all requirements.

MECHANICAL AND ELECTRICAL INTERLOCKING FOR 3 AND 4-POLE CONTACTORS



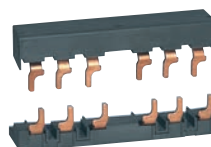

The mechanical interlock devices, with or without electrical interlocking, can be used to create 9 to 800 A inverters for 3P contactors, and 20 to 900 A inverters for 3P contactors.



The connection kits make it very easy to create reversing contactors up to 100 A.

MPCBs MPX³

technical characteristics

																								
MPCB		MPX³ 32S										MPX³ 32H												
	Size	1										2												
	Type	Thermal magnetic										Thermal magnetic												
	Breaking capacity	Standard										High												
	Handle type	Toggle										Rotary												
	Number of poles	3										3												
Characteristics of use																								
	Rated operational voltage (Ue)	Up to 690 V										Up to 690 V												
	Rated frequency	50/60 Hz										50/60 Hz												
	Rated insulation voltage (Ui)	690 V										690 V												
	Rated impulse voltage (Uimp)	6 kV										6 kV												
Utilisation category	IEC 60947-2 (breaker)	Cat. A										Cat. A												
	IEC 60947-4 (Motor starter)	AC3										AC3												
	Mechanical endurance (Operating)	100000										100000												
	Electric endurance (Cycles)	100000										100000												
	Max operating frequency per hour (Ope./h)	25										25												
	Temperature compensation	-20 to +60 °C										-20 to +60 °C												
	Instantaneous short circuit release	13 x Ie max.										13 x Ie max.												
	Trip class	10										10												
	Overload protection	•										•												
	Phase failure protection	•										•												
	Trip indicating function	with alarm contact 4 174 06/07										with alarm contact 4 174 06/07												
	Test function	•										•												
	Weight (g)	320										360												
Rated breaking capacity (kA)	Rated operational current Ie (A)	Thermal release adjustment range (A)	240 V		415 V		460 V		525 V		690 V		240 V		415 V		460 V		525 V		690 V			
			230 V	220 V	400 V	440 V	500 V	600 V	230 V	220 V	400 V	440 V	500 V	600 V	l_{cu}	l_{cs}	l_{cu}	l_{cs}	l_{cu}	l_{cs}	l_{cu}	l_{cs}	l_{cu}	l_{cs}
	0.16	0.1 to 0.16	100	100	100	100	100	100	100	100	100	100	100	100	100	100	100	100	100	100	100	100	100	100
	0.25	0.16 to 0.25	100	100	100	100	100	100	100	100	100	100	100	100	100	100	100	100	100	100	100	100	100	100
	0.4	0.25 to 0.4	100	100	100	100	100	100	100	100	100	100	100	100	100	100	100	100	100	100	100	100	100	100
	0.63	0.4 to 0.63	100	100	100	100	100	100	100	100	100	100	100	100	100	100	100	100	100	100	100	100	100	100
	1	0.63 to 1	100	100	100	100	100	100	100	100	100	100	100	100	100	100	100	100	100	100	100	100	100	100
	1.6	1 to 1.6	100	100	100	100	100	100	100	100	3	3	100	100	100	100	100	100	100	100	100	100	100	100
	2.5	1.6 to 2.5	100	100	100	100	100	100	50	38	3	3	100	100	100	100	100	100	100	100	8	8	8	8
	4	2.5 to 4	100	100	100	100	50	38	15	11	3	3	100	100	100	100	100	100	100	100	8	8	8	8
	6	4 to 6	100	100	100	100	15	11	10	8	3	3	100	100	100	100	100	100	100	100	6	6	6	6
	8	5 to 8	100	100	100	100	15	11	10	8	3	3	100	100	100	100	50	38	50	38	6	6	6	6
	10	6 to 10	100	100	50	38	15	11	6	5	3	3	100	100	100	100	50	38	50	38	6	6	6	6
	13	9 to 13	100	100	50	38	10	8	6	5	3	3	100	100	100	100	50	38	42	32	6	6	6	6
	17	11 to 17	50	38	20	15	10	8	6	5	3	3	100	100	50	38	20	15	10	8	4	4	4	4
	22	14 to 22	40	30	15	11	8	6	6	5	3	3	100	100	50	38	20	15	10	8	4	4	4	4
	26	18 to 26	40	30	15	11	8	6	5	4	3	3	100	100	50	38	20	15	10	8	4	4	4	4
	32	22 to 32	30	22	15	11	6	4	5	4	3	3	100	100	50	38	20	15	10	8	4	4	4	4
	40	28 to 40	-	-	-	-	-	-	-	-	-	-	-	-	-	-	-	-	-	-	-	-	-	-
	50	34 to 50	-	-	-	-	-	-	-	-	-	-	-	-	-	-	-	-	-	-	-	-	-	-
	63	45 to 63	-	-	-	-	-	-	-	-	-	-	-	-	-	-	-	-	-	-	-	-	-	-
	75	55 to 75	-	-	-	-	-	-	-	-	-	-	-	-	-	-	-	-	-	-	-	-	-	-
	90	70 to 90	-	-	-	-	-	-	-	-	-	-	-	-	-	-	-	-	-	-	-	-	-	-
	100	80 to 100	-	-	-	-	-	-	-	-	-	-	-	-	-	-	-	-	-	-	-	-	-	-



MPX³ 32MA

2
Magnetic only
High
Rotary
3



MPX³ 63H

3
Thermal magnetic
High
Rotary
3



MPX³ 100H

4
Thermal magnetic
High
Rotary
3

Up to 690 V

50/60 Hz

690 V

6 kV

Cat. A

AC3

100000

100000

25

-20 to +60 °C

13 x I_e max.

0

-

-

with alarm contact 4 174 06/07

•

360

Up to 690 V

50/60 Hz

1000 V

8 kV

Cat. A

AC3

50000

25000

25

-20 to +60 °C

13 x I_e max.

10

•

•

with alarm contact 4 174 07/08

•

1000

Up to 690 V

50/60 Hz

1000 V

8 kV

Cat. A

AC3

50000

25000

25

-20 to +60 °C

13 x I_e max.

10

•

•

with alarm contact 4 174 07/08

•

2200

240 V 230 V 220 V		415 V 400 V		460 V 440 V		525 V 500 V		690 V 600 V		240 V 230 V 220 V		415 V 400 V		460 V 440 V		525 V 500 V		690 V 600 V		240 V 230 V 220 V		415 V 400 V		460 V 440 V		525 V 500 V		690 V 600 V	
I _{cu}	I _{cs}	I _{cu}	I _{cs}	I _{cu}	I _{cs}	I _{cu}	I _{cs}	I _{cu}	I _{cs}	I _{cu}	I _{cs}	I _{cu}	I _{cs}	I _{cu}	I _{cs}	I _{cu}	I _{cs}	I _{cu}	I _{cs}	I _{cu}	I _{cs}	I _{cu}	I _{cs}	I _{cu}	I _{cs}	I _{cu}	I _{cs}	I _{cu}	I _{cs}
100	100	100	100	100	100	100	100	100	100	-	-	-	-	-	-	-	-	-	-	-	-	-	-	-	-	-	-	-	-
100	100	100	100	100	100	100	100	100	100	-	-	-	-	-	-	-	-	-	-	-	-	-	-	-	-	-	-	-	-
100	100	100	100	100	100	100	100	100	100	-	-	-	-	-	-	-	-	-	-	-	-	-	-	-	-	-	-	-	-
100	100	100	100	100	100	100	100	100	100	-	-	-	-	-	-	-	-	-	-	-	-	-	-	-	-	-	-	-	-
100	100	100	100	100	100	100	100	100	100	-	-	-	-	-	-	-	-	-	-	-	-	-	-	-	-	-	-	-	-
100	100	100	100	100	100	100	100	100	100	-	-	-	-	-	-	-	-	-	-	-	-	-	-	-	-	-	-	-	-
100	100	100	100	100	100	100	100	100	8	8	-	-	-	-	-	-	-	-	-	-	-	-	-	-	-	-	-	-	-
100	100	100	100	100	100	100	100	100	8	8	-	-	-	-	-	-	-	-	-	-	-	-	-	-	-	-	-	-	-
100	100	100	100	100	100	100	100	6	6	-	-	-	-	-	-	-	-	-	-	-	-	-	-	-	-	-	-	-	-
100	100	100	100	50	38	50	38	6	6	-	-	-	-	-	-	-	-	-	-	-	-	-	-	-	-	-	-	-	-
100	100	100	100	50	38	50	38	6	6	100	100	100	100	50	38	50	38	6	5	-	-	-	-	-	-	-	-	-	-
100	100	100	100	50	38	42	32	6	6	100	100	100	100	50	38	42	32	6	5	-	-	-	-	-	-	-	-	-	-
100	100	50	38	20	15	10	8	4	4	100	100	50	50	50	38	12	9	5	5	100	100	100	100	50	38	35	27	12	9
100	100	50	38	20	15	10	8	4	4	100	100	50	50	50	38	12	9	5	5	100	100	100	50	50	38	35	27	12	9
100	100	50	38	20	15	10	8	4	4	100	100	50	50	35	27	12	9	5	5	100	100	100	50	50	38	35	27	12	9
100	100	50	38	20	15	10	8	4	4	100	100	50	50	35	27	10	8	5	5	100	100	100	50	50	38	25	19	12	9
-	-	-	-	-	-	-	-	-	-	100	100	50	50	35	27	10	8	5	5	100	100	100	50	50	38	20	15	12	9
-	-	-	-	-	-	-	-	-	-	100	100	50	50	35	27	10	8	5	5	100	100	100	50	50	38	15	11	10	8
-	-	-	-	-	-	-	-	-	-	100	100	50	50	35	27	10	8	5	5	100	100	100	50	50	38	15	11	8	6
-	-	-	-	-	-	-	-	-	-	-	-	-	-	-	-	-	-	-	-	100	100	75	50	50	38	12	9	6	6
-	-	-	-	-	-	-	-	-	-	-	-	-	-	-	-	-	-	-	-	100	100	75	50	50	38	12	9	6	6
-	-	-	-	-	-	-	-	-	-	-	-	-	-	-	-	-	-	-	-	100	100	75	50	50	38	12	9	6	6

MPCBs MPX³

motor protection circuit breakers from 0.16 A to 100 A



Technical characteristics and tripping curves **p. 20-23**
 Dimensions and wiring capacity chart **p. 24-27**

Conform to IEC 60947-1, IEC 60947-2, IEC 60947-4

Pack	Cat. Nos	Thermal magnetic MPCBs			
		Adjustable thermal release Magnetic release 13 le max. MPX³ 32S Standard breaking capacity With toggle handle Fixing on rail			
		3-phase motor 400/415 V (kW)	Thermal release adjustment range (A)	Magnetic release operating current (A)	415 V breaking capacity Icu (kA)
	3P				
1	4 173 00	0.02	0.1 to 0.16	2.1	100
1	4 173 01	0.06	0.16 to 0.25	3.3	100
1	4 173 02	0.09	0.25 to 0.4	5.2	100
1	4 173 03	0.12	0.4 to 0.63	8.2	100
1	4 173 04	0.18/0.25	0.63 to 1	13	100
1	4 173 05	0.37/0.55	1 to 1.6	20.8	100
1	4 173 06	0.75	1.6 to 2.5	32.5	100
1	4 173 07	1.5	2.5 to 4	52	100
1	4 173 08	2.2	4 to 6	78	100
1	4 173 09	3	5 to 8	104	100
1	4 173 10	4	6 to 10	130	50
1	4 173 11	5.5	9 to 13	169	50
1	4 173 12	7.5	11 to 17	221	20
1	4 173 13	7.5	14 to 22	286	15
1	4 173 14	11	18 to 26	338	15
1	4 173 15	15	22 to 32	416	15
		MPX³ 32H High breaking capacity With rotary handle Fixing on rail			
1	4 173 20	0.02	0.1 to 0.16	2.1	100
1	4 173 21	0.06	0.16 to 0.25	3.3	100
1	4 173 22	0.09	0.25 to 0.4	5.2	100
1	4 173 23	0.12	0.4 to 0.63	8.2	100
1	4 173 24	0.18/0.25	0.63 to 1	13	100
1	4 173 25	0.37/0.55	1 to 1.6	20.8	100
1	4 173 26	0.75	1.6 to 2.5	32.5	100
1	4 173 27	1.5	2.5 to 4	52	100
1	4 173 28	2.2	4 to 6	78	100
1	4 173 29	3	5 to 8	104	100
1	4 173 30	4	6 to 10	130	100
1	4 173 31	5.5	9 to 13	169	100
1	4 173 32	7.5	11 to 17	221	50
1	4 173 33	7.5	14 to 22	286	50
1	4 173 34	11	18 to 26	338	50
1	4 173 35	15	22 to 32	416	50
		MPX³ 63H High breaking capacity With rotary handle Fixing on rail or by screw			
1	4 173 60	4	6 to 10	130	100
1	4 173 61	5.5	9 to 13	169	100
1	4 173 62	7.5	11 to 17	221	50
1	4 173 63	7.5	14 to 22	286	50
1	4 173 64	11	18 to 26	338	50
1	4 173 65	15	22 to 32	416	50
1	4 173 66	18.5	28 to 40	520	50
1	4 173 67	22	34 to 50	650	50
1	4 173 68	30	45 to 63	819	50

Pack	Cat. Nos	Thermal magnetic MPCBs (continued)			
		MPX³ 100H High breaking capacity With rotary handle Fixing on rail or by screw			
		3-phase motor 400/415 V (kW)	Thermal release adjustment range (A)	Magnetic release operating current (A)	415 V breaking capacity Icu (kA)
	3P				
1	4 173 70	7.5	11 to 17	221	100
1	4 173 71	7.5	14 to 22	286	100
1	4 173 72	11	18 to 26	338	100
1	4 173 73	15	22 to 32	416	100
1	4 173 74	18.5	28 to 40	520	100
1	4 173 75	22	34 to 50	650	100
1	4 173 76	30	45 to 63	819	100
1	4 173 77	37	55 to 75	975	75
1	4 173 78	45	70 to 90	1170	75
1	4 173 79	45	80 to 100	1300	75
		Magnetic only MPCBs Without thermal release Magnetic release 13 x le max. MPX³ 32MA High breaking capacity With rotary handle Fixing on rail			
		3-phase motor 400/415 V (kW)	Magnetic release operating current (A)	415 V breaking capacity Icu (kA)	
	3P				
1	4 173 40	0.02	2.1	100	
1	4 173 41	0.06	3.3	100	
1	4 173 42	0.09	5.2	100	
1	4 173 43	0.12	8.2	100	
1	4 173 44	0.18/0.25	13	100	
1	4 173 45	0.37/0.55	20.8	100	
1	4 173 46	0.75	32.5	100	
1	4 173 47	1.5	52	100	
1	4 173 48	2.2	78	100	
1	4 173 49	3	104	100	
1	4 173 50	4	130	100	
1	4 173 51	5.5	169	100	
1	4 173 52	7.5	221	50	
1	4 173 53	7.5	286	50	
1	4 173 54	11	338	50	
1	4 173 55	15	416	50	

MPCBs MPX³

accessories

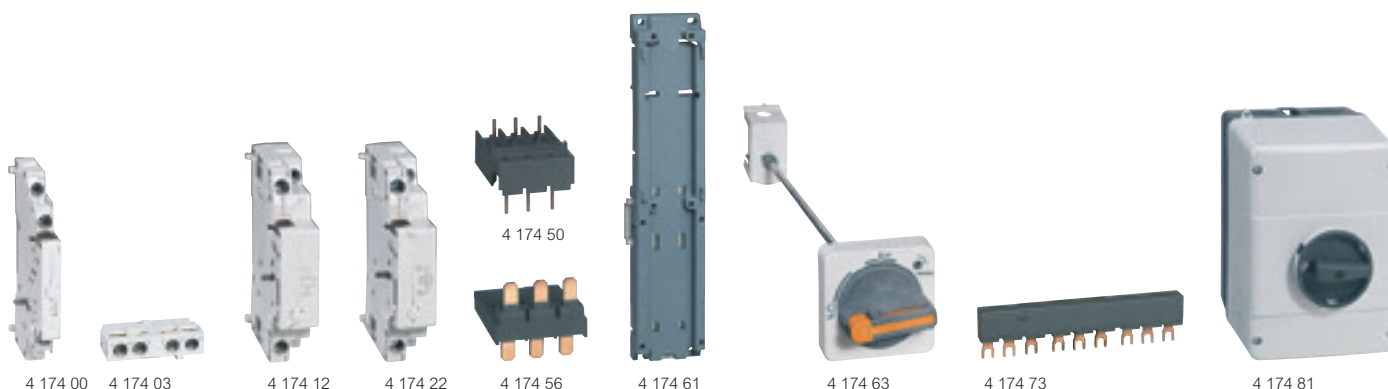

Pack	Cat. Nos	Auxiliary contacts	Pack	Cat. Nos	Direct adaptor and mounting unit
		2-pole Side mounting Mounting on the left side of MPCBs Two auxiliary contacts per MPCB 2 4 174 00 1 NO + 1 NC 2 4 174 01 2 NO 2 4 174 02 2 NC Front mounting One auxiliary contact per MPCB 10 4 174 03 1 NO + 1 NC 10 4 174 04 2 NO 10 4 174 05 2 NC			Direct adaptators Used to connect MPX ³ directly with the contactor 2 4 174 40 For MPX ³ 32S with CTX ³ mini AC (p. 30) 2 4 174 41 For MPX ³ 32S with CTX ³ mini DC (p. 30) 2 4 174 42 For MPX ³ 32H/32MA with CTX ³ mini AC (p. 30) 2 4 174 43 For MPX ³ 32H/32MA with CTX ³ mini DC (p. 30) 2 4 174 48 For MPX ³ 32S with CTX ³ 22 AC (p. 32) 2 4 174 49 For MPX ³ 32S with CTX ³ 22 DC (p. 32) 2 4 174 50 For MPX ³ 32H/32MA with CTX ³ 22 AC (p. 32) 2 4 174 51 For MPX ³ 32H/32MA with CTX ³ 22 DC (p. 32) 2 4 174 52 For MPX ³ 32S with CTX ³ 40 AC (p. 32) 2 4 174 53 For MPX ³ 32S with CTX ³ 40 DC (p. 32) 2 4 174 54 For MPX ³ 32H/32MA with CTX ³ 40 AC (p. 32) 2 4 174 55 For MPX ³ 32H/32MA with CTX ³ 40 DC (p. 32) 2 4 174 56 For MPX ³ 63H with CTX ³ 65 AC with lug type terminals (p. 32) 2 4 174 57 For MPX ³ 63H with CTX ³ 65 DC with lug type terminals (p. 32) 1 4 174 58 For MPX ³ 100H with CTX ³ 100 AC with lug type terminals (p. 33) 1 4 174 59 For MPX ³ 100H with CTX ³ 100 DC with lug type terminals (p. 33)
		Alarm contacts 1 NO + 1 NC Any trip alarm contact Operate in case of trip Mounting on the left side of MPCBs Set alarm contact first in case of using auxiliary contact and alarm contact together (MPX ³ 63H can not accept auxiliary contact and alarm contact together) 1 4 174 06 For MPX ³ 32 1 4 174 08 For MPX ³ 63 and 100 Magnetic trip alarm contact Operate in case of instantaneous trip Mounting on the left side of MPCBs Set alarm contact first in case of using auxiliary contact together 2 4 174 07 1 NO + 1 NC			Mounting unit This device is used for joining together MPX ³ MCPBs and CTX ³ contactors Screws not supplied 1 4 174 60 For MPX ³ 32S/32H/32MA 1 4 174 61 For MPX ³ 63H 1 4 174 62 For MPX ³ 100H
		Shunt release Mounting on the right side of MPCBs One release per MPCB 1 4 174 10 24 V - 50 Hz / 28 V - 60 Hz 1 4 174 11 110 V - 50 Hz / 120 V - 60 Hz 1 4 174 12 220-230 V - 50 Hz / 240-260 V - 60 Hz 1 4 174 13 380-400 V - 50 Hz / 440-460 V - 60 Hz			Rotary handle Mounting on panel's door to control the MPX ³ 1 4 174 63 For MPX ³ 32H and 32 MA 1 4 174 64 For MPX ³ 63H 1 4 174 65 For MPX ³ 100H
		Undervoltage release Mounting on the right side of MPCBs One release per MPCB Without auxiliary contact 1 4 174 20 24 V - 50 Hz / 28 V - 60 Hz 1 4 174 21 110 V - 50 Hz / 120 V - 60 Hz 1 4 174 22 220-230 V - 50 Hz / 240-260 V - 60 Hz 1 4 174 23 380-400 V - 50 Hz / 440-460 V - 60 Hz With 2 NO auxiliary contacts Can not attach to MPX ³ 32S 1 4 174 30 24 V - 50 Hz / 28 V - 60 Hz 1 4 174 31 110 V - 50 Hz / 120 V - 60 Hz 1 4 174 32 220-230 V - 50 Hz / 240-260 V - 60 Hz 1 4 174 33 380-400 V - 50 Hz / 440-460 V - 60 Hz			Phase busbar For parallel connection of MPX ³ For MPX³ 32S, 32H and 32MA Rated current 63 A 10 4 174 71 2 devices 10 4 174 73 3 devices 10 4 174 75 4 devices 10 4 174 76 5 devices 4 4 174 77 Feeder for phase busbar For MPX³ 63H Rated current 108 A 4 4 174 72 2 devices 4 4 174 74 3 devices
		Dial Cover Sealable cover to protect the set value from the operation that is not intended For all types of MPX ³ 100 4 174 79			Enclosures for MPX³ 32H and 32MA IP 65 enclosure to use in dusty areas as well as in presence of corrosive gas or liquid Yellow/red with rotary handle 1 4 174 80 With black rotary handle 1 4 174 81

MPCBs MPX³

wiring capacity and accessories

Mounting

MPX³ 32: 35 mm rail (depth 15 mm)
 MPX³ 63: 35 mm rail (depth 15 mm) or screws
 MPX³ 100: 35 mm (depth 15 mm) or 75 mm rail or screws

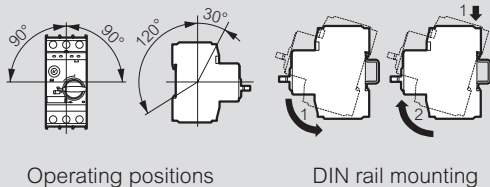

Caution for thermal adjustments

1. Keep the setting range as shown below
2. Moving counterclockwise out of the setting range may cause the damage of the device

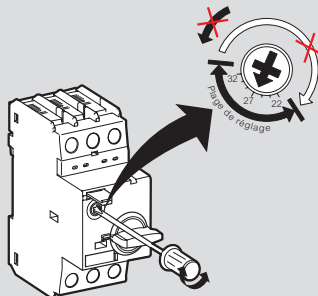

Dial setting method

3. Calibration by ambient air temperature

A: set to one point lower	Calibrated automatically	B: set to one point higher
-20 °C	-5 °C	+40 °C
+60 °C		

In case of using out of the standard air temperature range (-5 °C to +40 °C) it needs to be calibrated by one point

Environment

Ambient air temperature:
 - storage: -50...+80 °C
 - operation: -20...+60 °C
 Ambient temperature compensation: -20...+60 °C
 Maximum operating altitude: 2000 m
 Protection degree: IP20
 Shock resistance: 25 g
 Vibration resistance: 5~150 Hz

Power consumption

	MPX ³ 32S	MPX ³ 32H/MA	MPX ³ 63H	MPX ³ 100H
Total power loss Pv	In = 0.16 to 1.6 A: 4.4	In = 0.16 to 1.6 A: 4.4	In = 10 to 22 A: 10.2	In = 17 to 32 A : 15
Circuit breaker at rated load operating temperature (W)	In = 2.5 to 26 A : 7.4 In = 32 A : 4.0	In = 2.5 to 26 A : 7.4 In = 32 A : 4.0	In = 26 to 63 A: 9.7	In = 40 to 63 A : 21.8 In = 75 to 100 A: 17.8

MPX³ 32S

Rated operational current I _e (A)	0.16	0.25	0.4	0.63	1	1.6	2.5	4	6	8	10	13	17	22	26	32
Switching of standard three-phase motors AC-2, AC-3																
230/240V (kW)	-	0.03	0.06	0.09	0.12	0.18/0.25	0.37	0.55/0.75	1.1/1.5	1.5	2.2/3	3	3.7/4	4	5.5	7.5
400/415V (kW)	0.02	0.06	0.09	0.12	0.18/0.25	0.37/0.55	0.75	1.1/1.5	2.2	3	3.7/4	5.5	7.5	7.5	11	15
500V (kW)	-	-	-	0.25	0.37	0.55/0.75	1.1	1.5/2.2	3	3.7	4/5.5	7.5	11	11	15	18.5
690V (kW)	-	-	-	0.25	0.37/0.55	0.75/1.1	1.5	2.2/3	3.7/4	5.5	7.5	11	11	15	18.5	22
Back-up fuses gG, gL, only if I_{cc} > I_{cu} (* = no back up fuse required)																
230/240V (A)	*	*	*	*	*	*	*	*	*	*	*	*	*	125	125	125
400/415V (A)	*	*	*	*	*	*	*	*	*	*	*	80	80	100	100	100
440/460V (A)	*	*	*	*	*	*	*	50	50	63	63	80	80	100	100	100
500V (A)	*	*	*	*	*	*	50	40	50	63	63	80	80	80	80	80
690V (A)	*	*	*	*	*	20	35	40	50	63	63	63	63	63	63	63

MPX³ 32H

Rated operational current I _e (A)	0.16	0.25	0.4	0.63	1	1.6	2.5	4	6	8	10	13	17	22	26	32
Switching of standard three-phase motors AC-2, AC-3																
230/240V (kW)	-	0.03	0.06	0.09	0.12	0.18/0.25	0.37	0.55/0.75	1.1/1.5	1.5	2.2/3	3	3.7/4	4	5.5	7.5
400/415V (kW)	0.02	0.06	0.09	0.12	0.18/0.25	0.37/0.55	0.75	1.1/1.5	2.2	3	3.7/4	5.5	7.5	7.5	11	15
500V (kW)	-	-	-	0.25	0.37	0.55/0.75	1.1	1.5/2.2	3	3.7	4/5.5	7.5	11	11	15	18.5
690V (kW)	-	-	-	0.25	0.37/0.55	0.75/1.1	1.5	2.2/3	3.7/4	5.5	7.5	11	11	15	18.5	22
Back-up fuses gG, gL, only if I_{cc} > I_{cu} (* = no back up fuse required)																
230/240V (A)	*	*	*	*	*	*	*	*	*	*	*	*	*	*	*	*
400/415V (A)	*	*	*	*	*	*	*	*	*	*	*	*	100	125	125	125
440/460V (A)	*	*	*	*	*	*	*	*	*	80	80	80	80	100	100	100
500V (A)	*	*	*	*	*	*	*	*	*	63	80	80	80	80	80	80
690V (A)	*	*	*	*	*	*	35	40	50	63	63	63	63	63	63	63

MPX³ 32MA

Rated operational current I _e (A)	0.16	0.25	0.4	0.63	1	1.6	2.5	4	6	8	10	13	17	22	26	32
AC-2, AC-3																
230/240V (kW)	-	0.03	0.06	0.09	0.12	0.18/0.25	0.37	0.55/0.75	1.1/1.5	1.5	2.2/3	3	3.7/4	4	5.5	7.5
400/415V (kW)	0.02	0.06	0.09	0.12	0.18/0.25	0.37/0.55	0.75	1.1/1.5	2.2	3	3.7/4	5.5	7.5	7.5	11	15
500V (kW)	-	-	-	0.25	0.37	0.55/0.75	1.1	1.5/2.2	3	3.7	4/5.5	7.5	11	11	15	18.5
690V (kW)	-	-	-	0.25	0.37/0.55	0.75/1.1	1.5	2.2/3	3.7/4	5.5	7.5	11	11	15	18.5	22
Back-up fuses gG, gL, only if I_{cc} > I_{cu} (* = no back up fuse required)																
230/240V (A)	*	*	*	*	*	*	*	*	*	*	*	*	*	*	*	*
400/415V (A)	*	*	*	*	*	*	*	*	*	*	*	*	100	125	125	125
440/460V (A)	*	*	*	*	*	*	*	*	*	80	80	80	80	100	100	100
500V (A)	*	*	*	*	*	*	*	*	*	63	80	80	80	80	80	80
690V (A)	*	*	*	*	*	*	35	40	50	63	63	63	63	63	63	63

MPX³ 63H

Rated operational current I _e (A)	10	13	17	22	26	32	40	50	63
Switching of standard three-phase motors AC-2, AC-3									
230/240V (kW)	2.2/3	3	3.7/4	4	5.5	7.5	7.5	11	15
400/415V (kW)	3.7/4	5.5	7.5	7.5	11	15	18.5	22	30
500V (kW)	4/5.5	7.5	11	11	15	18.5	22	30	37
690V (kW)	7.5	11	11	15	18.5	22	30	45	55
Back-up fuses gG, gL, only if I_{cc} > I_{cu} (* = no back up fuse required)									
230/240V (A)	*	*	*	*	*	*	*	*	*
400/415V (A)	*	*	100	125	125	125	160	160	160
440/460V (A)	100	100	100	125	125	125	125	125	160
500V (A)	100	100	100	100	100	100	100	100	100
690V (A)	63	63	63	80	80	80	80	80	80

MPX³ 100H

Rated operational current I _e (A)	17	22	26	32	40	50	63	75	90	100
Switching of standard three-phase motors AC-2, AC-3										
230/240V (kW)	3.7/4	4	5.5	7.5	7.5	11	15	22	30	30
400/415V (kW)	7.5	7.5	11	15	18.5	22	30	37	45	45
500V (kW)	11	11	15	18.5	22	30	37	45	55	63
690V (kW)	11	15	18.5	22	30	45	55	63	75	90
Back-up fuses gG, gL, only if I_{cc} > I_{cu} (* = no back up fuse required)										
230/240V (A)	*	*	*	*	*	*	*	*	*	*
400/415V (A)	*	*	*	*	*	*	*	*	*	*
440/460V (A)	125	125	125	160	160	160	200	200	200	200
500V (A)	100	125	125	125	160	160	160	160	160	160
690V (A)	80	80	80	80	80	100	100	125	160	160

Number of auxiliaries per circuit breaker

Auxiliaries	MPX ³ 32S	MPX ³ 32H/MA	MPX ³ 63H	MPX ³ 100H
Auxiliary contact	front mounting	1	1	1
	side mounting	1	1	1
Fault signalling contact	1	1	1	1
Shunt release or undervoltage release	1	1	1	1

MPCBs MPX³

curves

Tripping curves

MPX³ 32S / 32H / 32MA

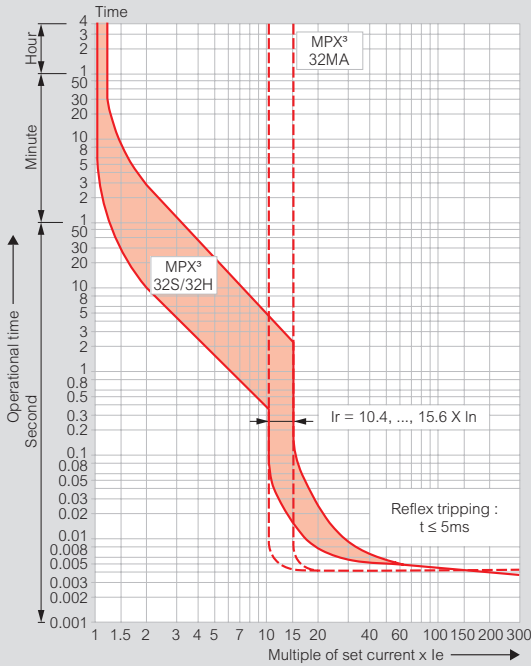

MPX³ 63H / 100H

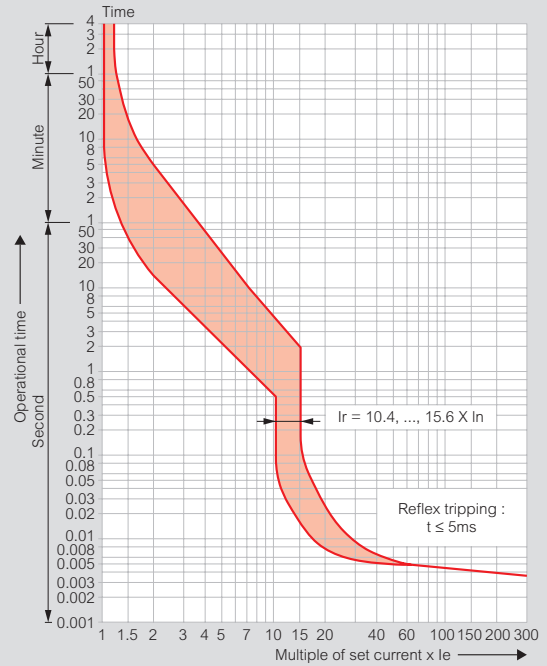

1) Thermal release trip current :

The adjustable inverse bimetal trip reliability protects motors against overloads. The curve shows the mean operating current at an ambient temperature of 20 °C starting from cold. Careful testing and setting ensures effective motor protection even in the case of single-phasing.

2) Current setting Ie :

The overload trip corresponds to a thermal overload relay in a motor starter conforming to IEC 947-4-1. If a different value is prescribed (e.g. reduced Ie for cooling medium having a temperature higher than 40 °C or a place of installation higher than 2000m above sea level), the setting current is equal to the reduced rated current Ie of the motor, as per manufacturer specifications.

When the MCPB is used outside the standard air temperature range (-5°C to +40°C) the thermal release needs to be calibrated by one point: one point lower from -20°C to -5°C and one point higher from +40°C to +60°C.

3) Magnetic release trip current :

The instantaneous magnetic trip has a fixed operating current setting.

This corresponds to 13 times the maximum value of setting range, at a lower setting it is correspondingly higher.

Thermal limit in kA²s in the magnetic operating zone (Ue=415V)

MPX³ 32S

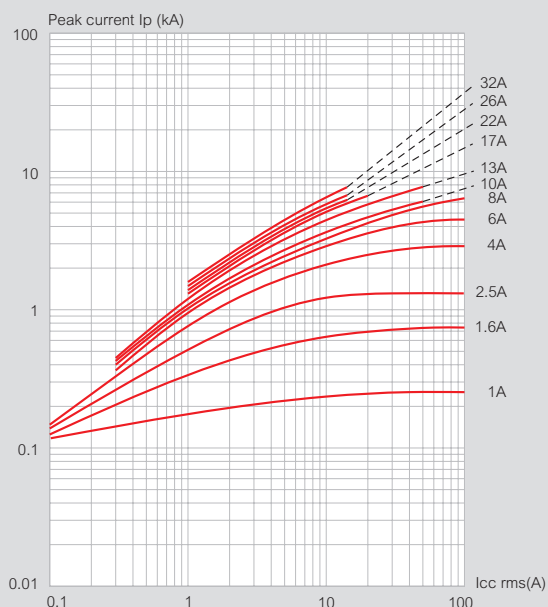
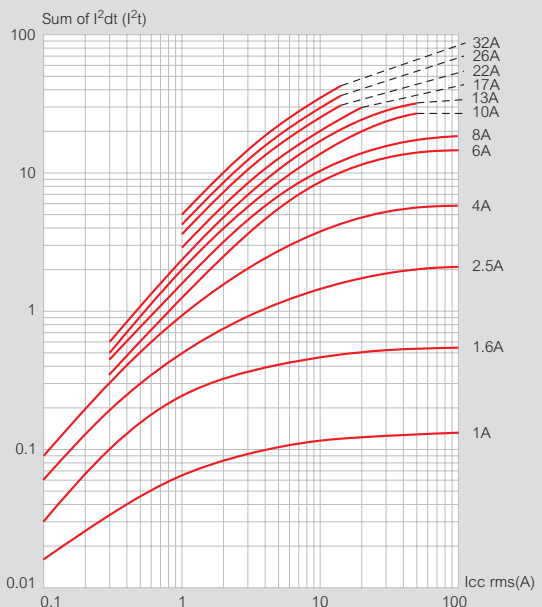

Thermal limit in kA²s in the magnetic operating zone (U_e=415V) (continued)

MPX³ 32H / 32MA

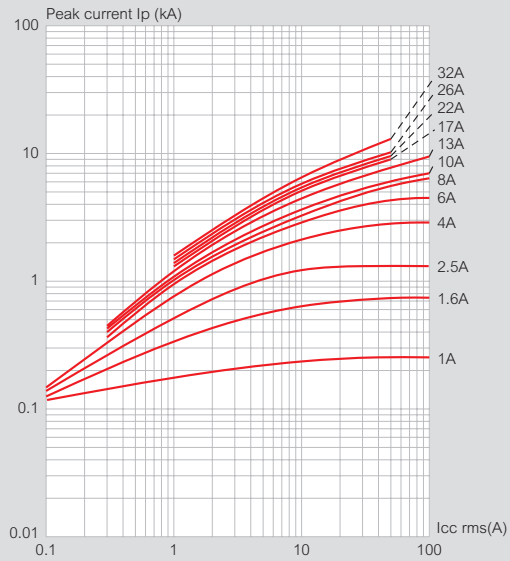
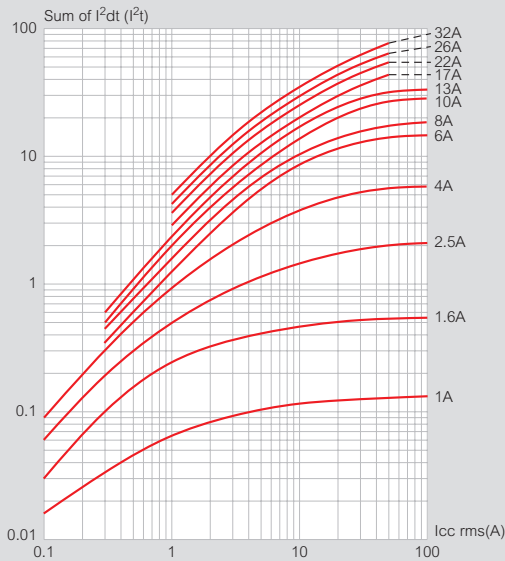

MPX³ 63H

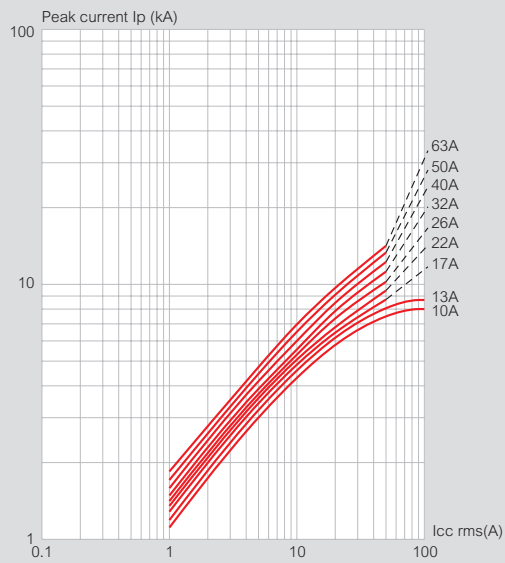
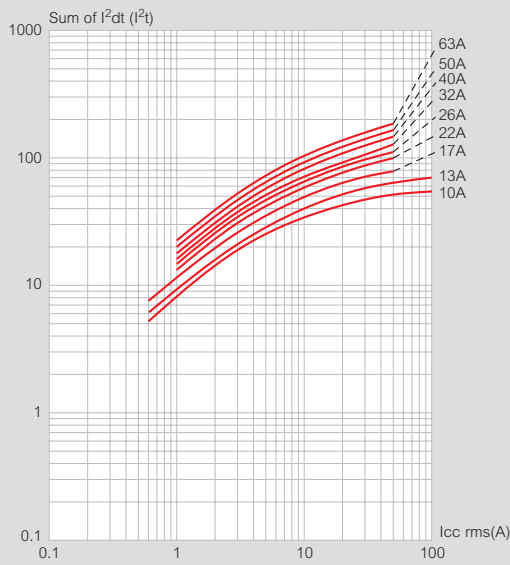

MPX³ 100H

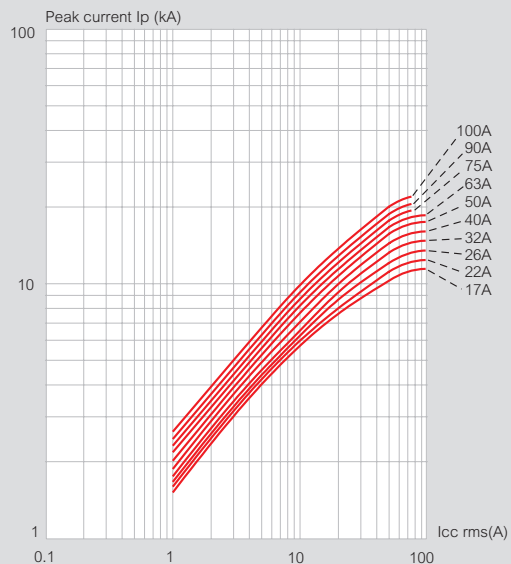
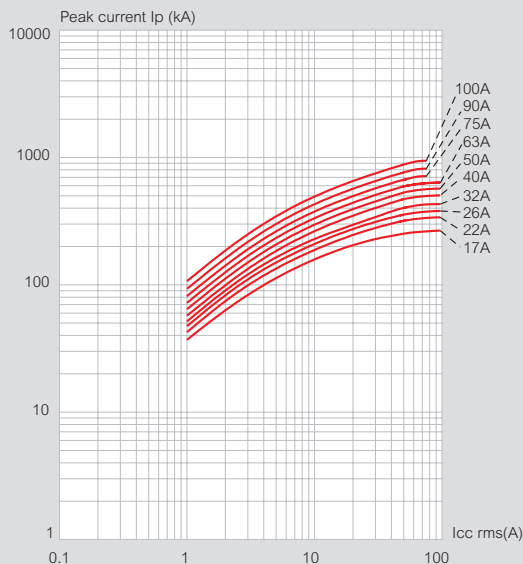

MPCBs MPX³

dimensions

MPX³ 32S

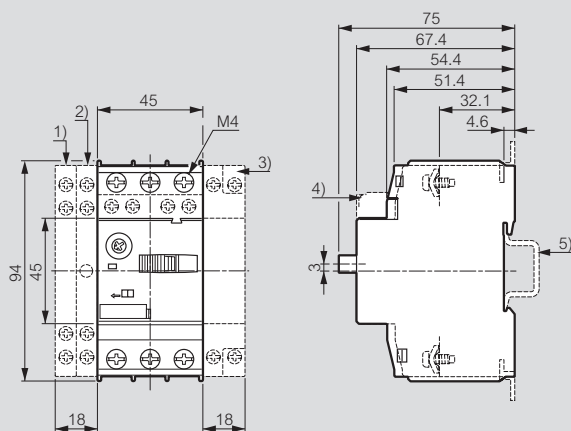

Weight: 0.320 kg

- 1) Side auxiliary contact
- 2) Side magnetic trip alarm contact
- 3) Side shunt release or Side undervoltage release
- 4) Front auxiliary contact
- 5) 35 mm standard mounting rail acc. to EN 50 022

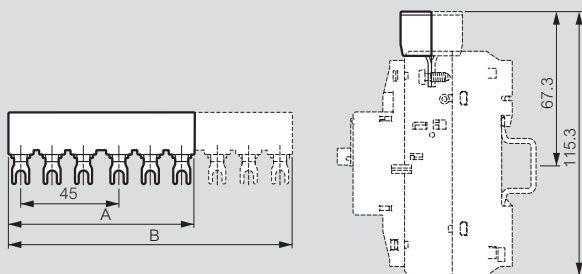

Cat.Nos	Numbers of MPX ³	A ⁽¹⁾ (mm)	B (mm)
4 174 71	2	85	-
4 174 73	3	-	130
4 174 75	4	-	175
4 174 76	5	-	220

(1) Only for Cat.No 4 174 71

MPX³ 32H / 32MA

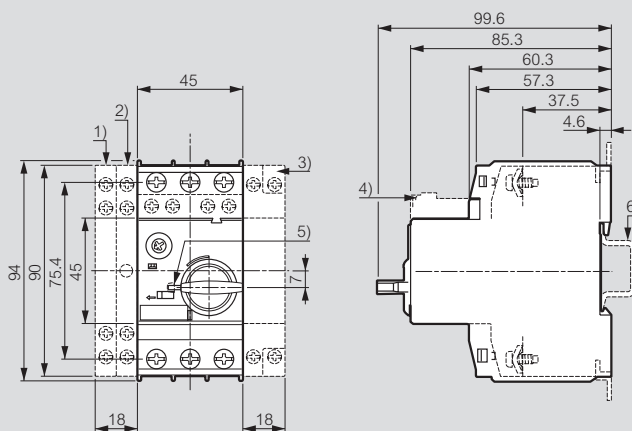

Weight: 0.360 kg

- 1) Side auxiliary contact
- 2) Side magnetic trip alarm contact
- 3) Side shunt release or Side undervoltage release
- 4) Front auxiliary contact
- 5) Handle lock in OFF position (Ø 5 mm)
- 6) 35 mm standard mounting rail acc. to EN 50 022

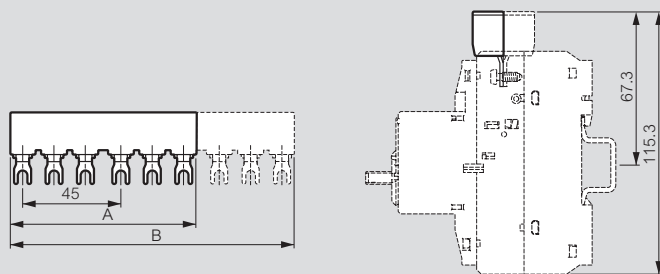

Cat.Nos	Numbers of MPX ³	A ⁽¹⁾ (mm)	B (mm)
4 174 71	2	85	-
4 174 73	3	-	130
4 174 75	4	-	175
4 174 76	5	-	220

(1) Only for Cat.No 4 174 71

MPX³ 63H

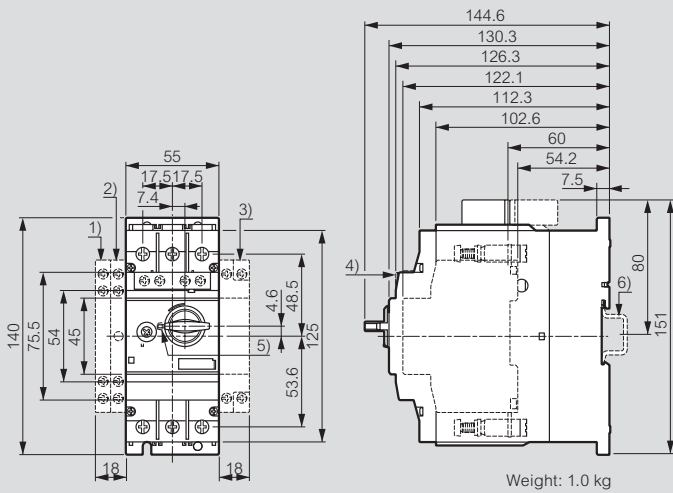

Weight: 1.0 kg

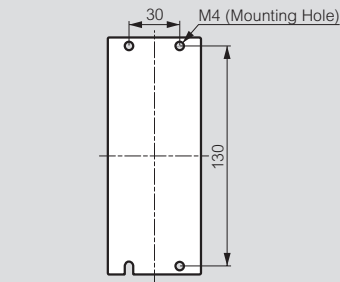

- 1) Side auxiliary contact
- 2) Side magnetic trip alarm contact
- 3) Side shunt release or Side undervoltage release
- 4) Front auxiliary contact
- 5) Handle lock in OFF position (Ø 5 mm)
- 6) 35 mm standard mounting rail acc. to EN 50 022

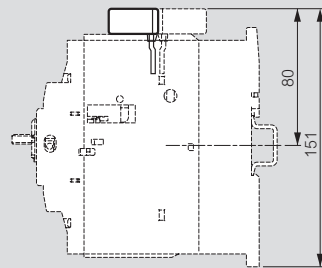
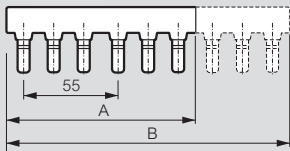

Cat.Nos	Numbers of MPX ³	A ⁽¹⁾ (mm)	B (mm)
4 174 72	2	110	-
4 174 74	3	-	165

(1) Only for Cat.No 4 174 72

MPX³ 100H

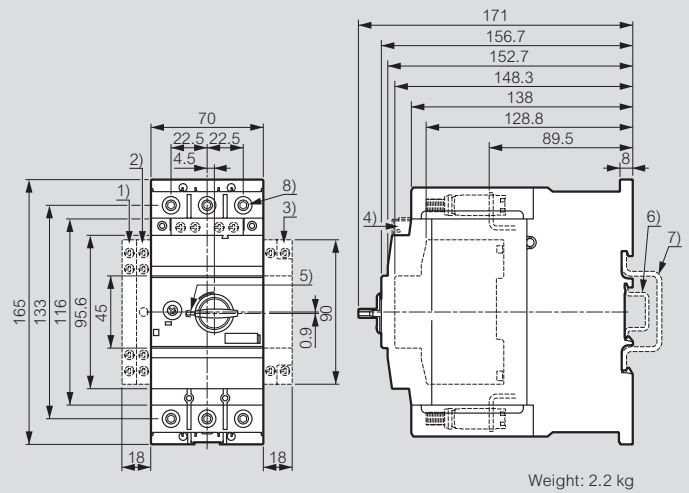

Weight: 2.2 kg

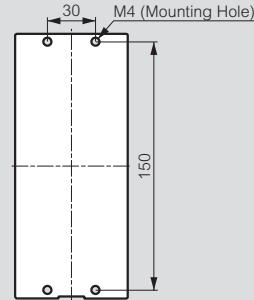

- 1) Side auxiliary contact
- 2) Side magnetic trip alarm contact
- 3) Side shunt release or Side undervoltage release
- 4) Front auxiliary contact
- 5) Handle lock in OFF position (Ø 5 mm)
- 6) 35 mm standard mounting rail acc. to EN 50 022
- 7) 75 mm standard mounting rail acc. to EN 50 023
- 8) 4 mm hexagon socket screw

MPCBs MPX³

dimensions (continued)

External Handle

MPX³ 32H / 32MA - Cat.No 4 174 63

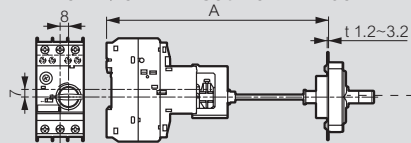

MPX³ 63H - Cat.No 4 174 64

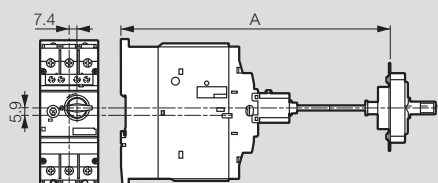

MPX³ 100H - Cat.No 4 174 65

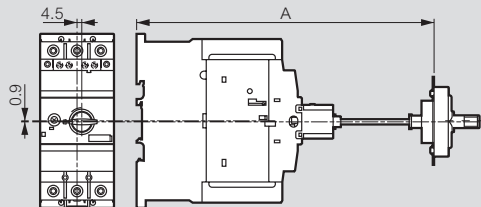

Cat.Nos	A (mm)	MMS Type
4 174 63	min: 148.6	MPX ³ 32H / 32MA
	max: 410.6 (Shaft 315mm)	
4 174 64	min: 193.6	MPX ³ 63H
	max: 455.6 (Shaft 315mm)	
4 174 65	min: 220	MPX ³ 100H
	max: 482 (Shaft 315mm)	

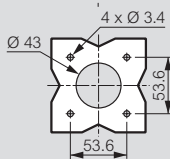

Phase Bus

Cat.Nos 4 174 71/73/75/76

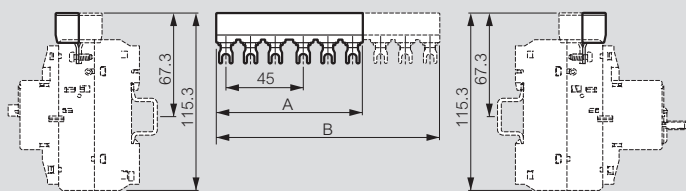

Cat.Nos 4 174 72/74

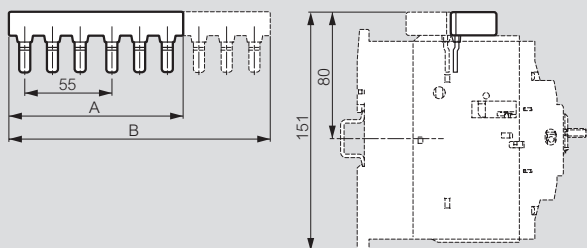

Cat.Nos	Number of MPX ³	A (mm)	B (mm)
4 174 71	2	85	-
4 174 72	3	-	130
4 174 73	2	110	-
4 174 74	3	-	165
4 174 75	4	-	175
4 174 76	5	-	220

Enclosure

Cat.Nos 4 174 80/81

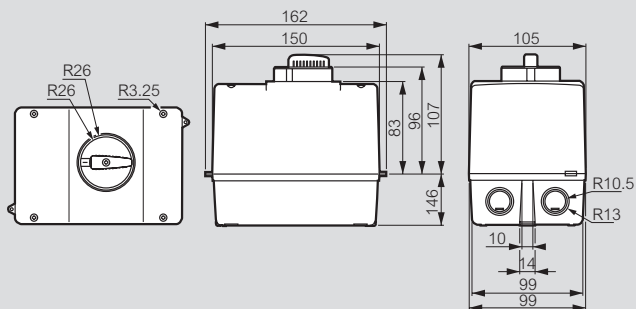

Mounting units - installation principle

Cat.Nos 4 174 60/61/62

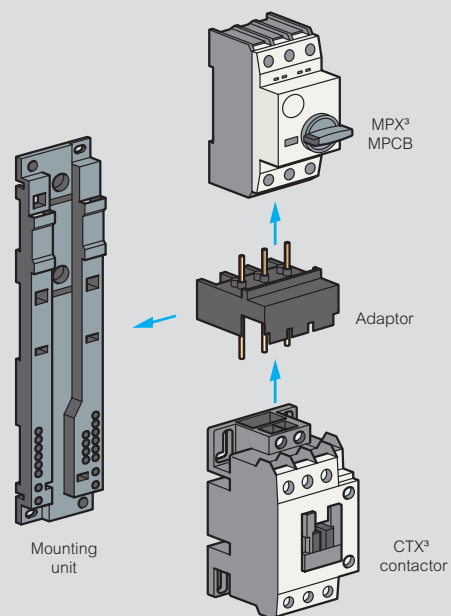





MPX ³ MPCB	CTX ³ contactor	Adaptor	Mounting unit
MPX ³ 32S	CTX ³ mini ~	4 174 40	4 174 60
	CTX ³ mini =	4 174 41	
	CTX ³ 22 ~	4 174 48	
	CTX ³ 22 =	4 174 49	
	CTX ³ 40 ~	4 174 52	
MPX ³ 32H/MA	CTX ³ 40 =	4 174 53	4 174 60
	CTX ³ mini ~	4 174 42	
	CTX ³ mini =	4 174 43	
	CTX ³ 22 ~	4 174 50	
	CTX ³ 22 =	4 174 51	
MPX ³ 63H	CTX ³ 40 ~	4 174 54	4 174 61
	CTX ³ 40 =	4 174 55	
	CTX ³ 65 ~	4 174 56	
MPX ³ 100H	CTX ³ 65 =	4 174 57	4 174 62
	CTX ³ 100 ~	4 174 58	
	CTX ³ 100 =	4 174 59	

MPCBs MPX³

technical characteristics

Terminals

			MPX ³ 32S	MPX ³ 32H / 32 MA	MPX ³ 63H	MPX ³ 100H
Conformity to standards			IEC60947 UL508, UL508 Type E			
Approvals			CE, UL			
Terminal type						
Single-core	1 conductor	(mm ²) / (AWG)	1...10 / 18...8	1...10 / 18...8	0.75...35 / 18...2	2.5...70 / 12...2/0
	2 conductor	(mm ²) / (AWG)	1...6 / 18...10	1...6 / 18...10	0.75...25 / 18...4	2.5...50 / 12...1/0
Stranded	1 conductor	(mm ²) / (AWG)	1...6 / 18...10	1...6 / 18...10	0.75...35 / 18...2	2.5...70 / 12...2/0
	2 conductor	(mm ²) / (AWG)	1...6 / 18...10	1...6 / 18...10	0.75...25 / 18...4	2.5...50 / 12...1/0
Flexible	1 conductor	(mm ²) / (AWG)	1...6 / 18...10	1...6 / 18...10	0.75...25 / 18...4	2.5...50 / 12...1/0
	2 conductor	(mm ²) / (AWG)	0.75...4 / 18...10	0.75...4 / 18...10	0.75...16 / 18...6	2.5...35 / 10...2
Tightening torque		(Nm) / (lb-in)	0.8...2.5 / 7...22	0.8...2.5 / 7...22	3...4.5 / 26...39	4...6 / 35...53







Auxiliaries





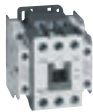







			Auxiliary contacts for front mounting		Auxiliary contacts for left side mounting		Alarm switch for left side mounting	
Rated thermal current / th at 40 °C ambient temperature	(A)		5		10		10	
	(A)		3		6		6	
Contact class coordination according to NEMA (UL/CSA-Standards)	AC		A600		A600		A600	
	DC		Q300		Q300		Q300	
Back-up fuses gG, gL	(A)		16		16		16	
Rated supply current	AC-15	(V)	-	240	24	240	24	240
		(A)	-	3	6	4	6	4
	DC-13	(V)	24	220	24	220	24	220
		(A)	1	0.1	2	0.25	2	0.25
Weight (g)			18		30		40	
Terminal type								
Screwdriver			Pozi driv size 2					
Single-core	1 conductor	(mm ²) / (AWG)	0.5...2.5 / 20...14		0.5...2.5 / 20...14			
	2 conductor	(mm ²) / (AWG)	-		0.5...2.5 / 20...14			
Stranded	1 conductor	(mm ²) / (AWG)	0.5...4 / 20...10		0.5...4 / 20...10			
	2 conductor	(mm ²) / (AWG)	0.75...2.5 / 18...14		0.75...2.5 / 18...14			
Tightening torque		(Nm) / (lb-in)	0.8...1.2 / 7...10		0.8...1.2 / 7...10			

			Undervoltage release for right side mounting	Undervoltage release with 2 auxiliary contacts for right side mounting	Shunt release for right side mounting
Actuating voltage	Pull-in		0.7...1.1 x Us	0.85...1.1 x Us	0.85...1.1 x Us
	Drop-out			0.7...0.35 x Us	0.7...0.35 x Us
Rated control voltage	min:		24 V 50 Hz / 28 V 60 Hz	24 V 50 Hz / 28 V 60 Hz	24 V 50 Hz / 28 V 60 Hz
	max:		415-440 V 50 Hz / 460-480 V 60 Hz	415-440 V 50 Hz / 460-480 V 60 Hz	415-440 V 50 Hz / 460-480 V 60 Hz
Coil rating	Pull-in		8.5 VA, 6 W	8.5 VA, 6 W	8.5 VA, 6 W
	Hold		3 VA, 12 W	3 VA, 12 W	3 VA, 12 W
Opening time (ms)			-	20	20
Weight (g)			18	30	40
Terminal type					
Screwdriver			Pozi driv size 2		
Single-core	1 conductor	(mm ²) / (AWG)	0.5...2.5 / 20...14		
	2 conductor	(mm ²) / (AWG)	0.5...2.5 / 20...14		
Standard	1 conductor	(mm ²) / (AWG)	0.5...4 / 20...10		
	2 conductor	(mm ²) / (AWG)	0.75...2.5 / 18...14		
Tightening torque		(Nm) / (lb-in)	0.8...1.2 / 7...10		

3-pole contactors CTX³ and thermal overload relays RTX³

technical characteristics

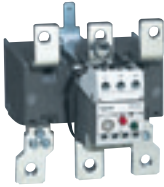
															
Contactor		CTX ³ mini				CTX ³ 22				CTX ³ 40					
Size		-				2				3					
Terminals type		screw				screw				screw					
Rated operational voltage, U _e		690 V				690 V				690 V					
Rated insulation voltage, U _i		690 V				690 V				1000 V					
Rated frequency		50/60 Hz				50/60 Hz				50/60 Hz					
Rated impulse withstand voltage, U _{imp}		6 kV				6 kV				8 kV					
Max. operating rate in operation cycle per hour (AC-3)		1800				1800				1800					
Durability in millions of operations		Mechanical				12				15					
		Electrical				1				2.5					
		Type				6 A				9 A					
						9 A				12 A					
						12 A				16 A					
						16 A				22 A					
						22 A				32 A					
						32 A				40 A					
Current and power		AC-1		Thermal current (A)		20		20		20		20			
		AC-3		200/240 V (kW)		1.5		2.2		3		4			
				(A)		7		9		12		15			
				380/440 V (kW)		2.2		4		5.5		7.5			
				(A)		6		9		12		16			
				500/550 V (kW)		3		3.7		4		5.5			
				(A)		5		6		7		9			
				690 V (kW)		3		4		4		4			
				(A)		4		5		5		5			
				1000 V (kW)		-		-		-		-			
(A)				-		-		-		-					
UL rating 50/60 Hz		Continuous current (A)		20		20		20		20		25			
		Single phase		110/220 V (HP)		1/2		1/2		1		-		0.5	
				220/240 V (HP)		1		1.5		2		-		1.5	
		Three phase		200/208 V (HP)		-		-		-		-		2	
				220/240 V (HP)		1.5		3		3		-		3	
				440/480 V (HP)		3		5		7.5		-		5	
				550/600 V (HP)		3		5		7.5		-		7.5	
NEMA size				00		00		00		0		00			
Weight and size		AC control		Weight (kg)		0.17				0.34					
				Size (W x H x D) (mm)		45 x 58 x 57				45 x 73.5 x 87.4					
		DC control		Weight (kg)		0.23				0.41					
				Size (W x H x D) (mm)		45 x 58 x 69				45 x 73.5 x 103.6					
		Integrated auxiliary contacts		1 NO or 1 NC				1 NO + 1 NC							
Add on auxiliary block		Side mounting		Yes				Yes							
		Front mounting		Yes				Yes							
Thermal overload relay		RTX ³ mini				RTX ³ 40				RTX ³ 40					
															
Terminals type		Standard RTX ³		-				screw							
		Differential RTX ³		screw				screw							
Rated operational voltage, U _e		690 V				690 V				690 V					
Rated insulation voltage, U _i		690 V				690 V				690 V					
Rated impulse withstand voltage, U _{imp}		6 kV				6 kV				6 kV					
Trip class		10 A				10 A				10 A					
Setting		0.1 to 16 A				0.1 to 40 A				0.1 to 40 A					
Weight and size		Weight (kg)		0.1				0.17							
		Size (W x H x D) (mm)		45 x 73 x 63				45 x 75 x 90							

														
CTX³ 65		CTX³ 100			CTX³ 150		CTX³ 225		CTX³ 400			CTX³ 800		
4		5			6		7		8			9		
screw or cage		screw or cage			screw or cage		screw		screw			screw		
690 V		690 V			690 V		690 V		690 V			690 V		
1000 V		1000 V			1000 V		1000 V		1000 V			1000 V		
50/60 Hz		50/60 Hz			50/60 Hz		50/60 Hz		50/60 Hz			50/60 Hz		
8 kV		8 kV			8 kV		8 kV		8 kV			8 kV		
1800		1800			1200		1200		1200			1200		
12		12			5		5		5		2.5	2.5		
2		2			1		1		1		0.5	0.5		
50 A	65 A	75 A	85 A	100 A	130 A	150 A	185 A	225 A	265 A	330 A	400 A	500 A	630 A	800 A
70	100	110	135	160	160	210	230	275	300	350	450	580	660	900
15	18.5	22	25	30	37	45	55	75	80	90	125	147	190	220
55	65	75	85	105	130	150	185	225	265	330	400	500	630	800
22	30	37	45	55	60	75	90	132	147	160	200	265	330	440
50	65	75	85	105	130	150	185	225	265	330	400	500	630	800
30	33	37	45	55	60	70	110	132	147	160	225	265	330	500
43	60	64	75	85	90	100	180	200	225	280	350	400	500	720
30	33	37	45	55	55	55	110	140	160	200	250	300	400	500
28	35	42	45	65	60	60	120	150	185	225	300	380	420	630
30	30	37	27	37	75	75	132	132	147	147	147	220	220	220
23	23	28	28	28	53	53	90	90	105	105	105	280	280	280
70	100	110	135	160	160	210	230	275	300	350	450	580	660	900
3	5	5	7.5	10	10	15	15	15	-	-	-	-	-	-
10	15	15	15	20	20	25	30	40	-	-	-	-	-	-
20	25	25	30	30	40	40	60	60	75	100	125	150	200	200
25	30	30	40	40	40	50	60	75	100	125	150	200	250	300
40	50	50	60	75	75	100	125	150	200	250	300	400	500	600
50	60	60	75	75	75	75	125	150	200	250	300	400	500	600
2	2	2	3	3	3	4	4	4	5	5	5	6	6	7
0.9		1.6			2.4		5.4		9.2			22.4		
55 × 106 × 119		70 × 140 × 135.8			95 × 158 × 130.3		138 × 203 × 185.1		163 × 243 × 204.4			285 × 312 × 245.3		
1.2		2.6			2.4		5.4		9.2			22.4		
55 × 106 × 146.4		70 × 140 × 172.3			95 × 158 × 130.3		138 × 203 × 185.1		163 × 243 × 204.4			285 × 312 × 245.3		
2 NO + 2 NC		2 NO + 2 NC			2 NO + 2 NC		2 NO + 2 NC		2 NO + 2 NC			2 NO + 2 NC		
Yes		Yes			Yes		Yes		Yes			Yes		
Yes		Yes			Yes		No		No			No		
RTX³ 65		RTX³ 100			RTX³ 150		RTX³ 225		RTX³ 400			RTX³ 800		
														
screw		screw			screw		-		-			-		
cage		cage			cage		screw		screw			screw		
690 V		690 V			690 V		690 V		690 V			690 V		
690 V		690 V			690 V		690 V		690 V			690 V		
6 kV		6 kV			6 kV		6 kV		6 kV			6 kV		
10 A		10 A			10 A		10 A		10 A			10 A		
9 to 65 A		18 to 100 A			45 to 150 A		65 to 240 A		85 to 400 A			200 to 800 A		
0.31/0.33		0.48/0.5			0.67		2.5		2.6			11.5		
55 × 81 × 100		70 × 97 × 110			95 × 109 × 113		147 × 141 × 184		151 × 171 × 198			360 × 530 × 212		

Mini contactors CTX³

6 to 16 A industrial contactors

Thermal relays and accessories

for mini contactors



4 170 00



4 170 01



4 170 88



4 171 55

Dimensions p. 31

Pack	Cat. Nos		3-pole mini contactors		
	Integrated auxiliary contact		With integrated auxiliary contact Power terminals: screw terminals		
	1 NO	1 NC	6 A (AC3)		
			3-phase motor 400/415 V	Control Voltage	
1	4 170 00	4 170 10	2.2 kW	24 V~	
1	4 170 01	4 170 11	2.2 kW	24 V=	
1	4 170 04	4 170 14	2.2 kW	110 V~	
1	4 170 06	4 170 16	2.2 kW	230 V~	
1	4 170 09	4 170 19	2.2 kW	415 V~	
			9 A (AC3)		
1	4 170 20	4 170 30	4 kW	24 V~	
1	4 170 21	4 170 31	4 kW	24 V=	
1	4 170 24	4 170 34	4 kW	110 V~	
1	4 170 26	4 170 36	4 kW	230 V~	
1	4 170 29	4 170 39	4 kW	415 V~	
			12 A (AC3)		
1	4 170 40	4 170 50	5.5 kW	24 V~	
1	4 170 41	4 170 51	5.5 kW	24 V=	
1	4 170 44	4 170 54	5.5 kW	110 V~	
1	4 170 46	4 170 56	5.5 kW	230 V~	
1	4 170 49	4 170 59	5.5 kW	415 V~	
			16 A (AC3)		
1	4 170 60	4 170 70	7.5 kW	24 V~	
1	4 170 61	4 170 71	7.5 kW	24 V=	
1	4 170 64	4 170 74	7.5 kW	110 V~	
1	4 170 66	4 170 76	7.5 kW	230 V~	
1	4 170 69	4 170 79	7.5 kW	415 V~	

Pack	Cat. Nos		4-pole mini contactors		
			Without integrated auxiliary contact Power terminals: screw terminals		
			20 A		
			Max. operating current AC 1	Max. operating current AC 3	Control Voltage
1	4 171 40		20 A	16 A	24 V~
1	4 171 41		20 A	16 A	24 V=
1	4 171 44		20 A	16 A	110 V~
1	4 171 46		20 A	16 A	230 V~
1	4 171 49		20 A	16 A	415 V~

Dimensions p. 31
 Tripping curves p. 49

Pack	Cat. Nos	Thermal overload relays for 3-pole mini contactors	
		Class 10A Integrated auxiliary contacts 1 NO + 1 NC	
1	4 170 80	0.16 A	
1	4 170 81	0.25 A	
1	4 170 82	0.40 A	
1	4 170 83	0.63 A	
1	4 170 84	1 A	
1	4 170 85	1.6 A	
1	4 170 86	2.5 A	
1	4 170 87	4 A	
1	4 170 88	6 A	
1	4 170 89	8 A	
1	4 170 90	9 A	
1	4 170 91	10 A	
1	4 170 92	13 A	
1	4 170 93	16 A	

Add on auxiliary blocks for mini contactors

Pack	Cat. Nos	lth : 10 A	
		Front mounting	
15	4 171 50	1 NO + 1 NC	
15	4 171 51	2 NO	
15	4 171 52	2 NC	
15	4 171 53	4 NO	
15	4 171 54	3 NO + 1 NC	
15	4 171 55	2 NO + 2 NC	
15	4 171 56	1 NO + 3 NC	
15	4 171 57	4 NC	
		Side mounting	
20	4 171 58	1 NO	
20	4 171 59	1 NC	

Pack	Cat. Nos	Interlock Unit	
1	4 171 60	Mechanical interlock for mini contactors	

Pack	Cat. Nos	Spare coils	
10	4 171 70	24 V~	
10	4 171 71	24 V=	
10	4 171 74	110 V~	
10	4 171 76	230 V~	
10	4 171 79	415 V~	

CTX³ control relays
p. 37



Mini contactors CTX³

technical characteristics and dimensions

Environmental conditions

- Storage temperature: -30 °C to +65 °C
- Operating temperature: -5 °C to +40 °C
- Operating altitude: 2000 m
- Protection degree: IP 20
- Shock resistance: 5 G
- Vibration resistance (10-55 Hz): 2 G

Possible combinations of auxiliary blocks per contactor

Auxiliary contact block	Maximum number of blocks		
	Side mounting (1 contact)	Front mounting (2 contacts)	Front mounting (4 contacts)
CTX ³ mini and control relay Control voltage : ~	2	0	1
	4	1	0
	6	0	0
CTX ³ mini and control relay Control voltage : =	2	0	0
	0	1	0

Mini contactors 3P and 4P and control relays

AC control

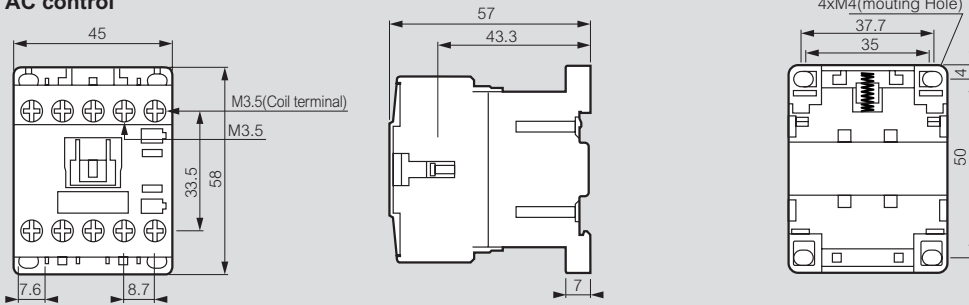

DC control

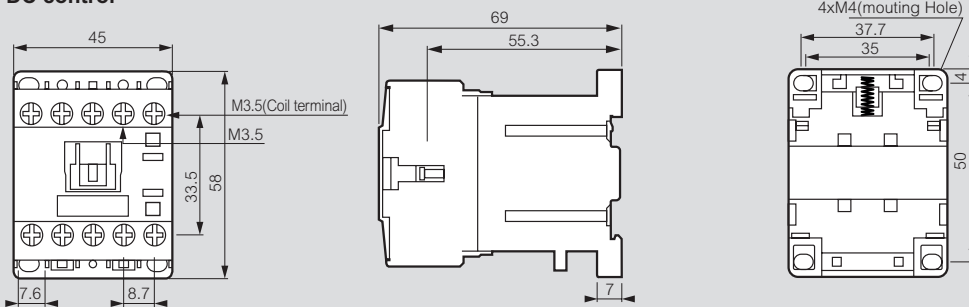

Thermal overload relays for mini contactors

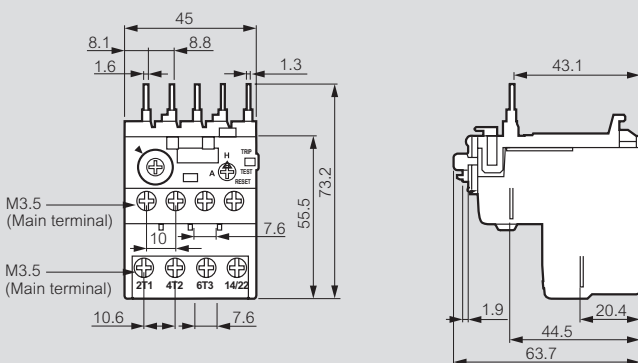

Auxiliary contacts

Front mounting

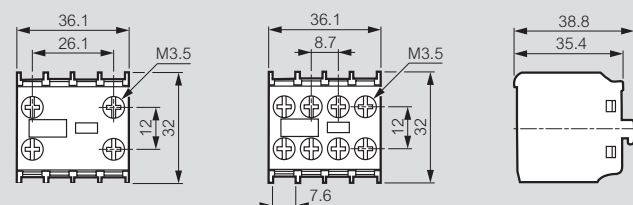

Side mounting

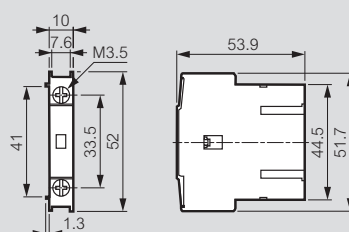

3-pole contactors CTX³

130 A to 800 A industrial contactors



Technical characteristics and coordination with circuit breakers **p. 38-39**
 Dimensions **p. 39-41**

Conform to IEC 60947-1, IEC 60947-4-1

Can be equipped with RTX³ thermal relays (p. 34-35) add-on auxiliary contact blocks, time delay blocks (except CTX³ 225/400/800) and CTX³ interlocking (p. 36)

Pack	Cat.Nos		CTX³ 100		
			With integrated auxiliary contacts		
			75 A (AC3) - 110 A (AC1)		
	Screw terminals	Cage terminals	3-phase motor 400/415 V	Control Voltage	Integrated auxiliary contacts
1	4 161 80	4 161 90	37 kW	24 V~	2 NO + 2 NC
1	4 161 81	4 161 91	37 kW	24 V=	2 NO + 2 NC
1	4 161 82	4 161 92	37 kW	48 V~	2 NO + 2 NC
1	4 161 83	4 161 93	37 kW	48 V=	2 NO + 2 NC
1	4 161 84	4 161 94	37 kW	110 V~	2 NO + 2 NC
1	4 161 86	4 161 96	37 kW	230 V~	2 NO + 2 NC
1	4 161 88	4 161 98	37 kW	380 V~	2 NO + 2 NC
1	4 161 89	4 161 99	37 kW	415 V~	2 NO + 2 NC
			85 A (AC3) - 135 A (AC1)		
1	4 162 00	4 162 10	45 kW	24 V~	2 NO + 2 NC
1	4 162 01	4 162 11	45 kW	24 V=	2 NO + 2 NC
1	4 162 02	4 162 12	45 kW	48 V~	2 NO + 2 NC
1	4 162 03	4 162 13	45 kW	48 V=	2 NO + 2 NC
1	4 162 04	4 162 14	45 kW	110 V~	2 NO + 2 NC
1	4 162 06	4 162 16	45 kW	230 V~	2 NO + 2 NC
1	4 162 08	4 162 18	45 kW	380 V~	2 NO + 2 NC
1	4 162 09	4 162 19	45 kW	415 V~	2 NO + 2 NC
			100 A (AC3) - 160 A (AC1)		
1	4 162 20	4 162 30	55 kW	24 V~	2 NO + 2 NC
1	4 162 21	4 162 31	55 kW	24 V=	2 NO + 2 NC
1	4 162 22	4 162 32	55 kW	48 V~	2 NO + 2 NC
1	4 162 23	4 162 33	55 kW	48 V=	2 NO + 2 NC
1	4 162 24	4 162 34	55 kW	110 V~	2 NO + 2 NC
1	4 162 26	4 162 36	55 kW	230 V~	2 NO + 2 NC
1	4 162 28	4 162 38	55 kW	380 V~	2 NO + 2 NC
1	4 162 29	4 162 39	55 kW	415 V~	2 NO + 2 NC

Pack	Cat.Nos		CTX³ 150		
			With integrated auxiliary contacts		
			130 A (AC3) - 160 A (AC1)		
	Screw terminals	Cage terminals	3-phase motor 400/415 V	Control Voltage	Integrated auxiliary contacts
1	4 162 40	4 162 50	60 kW	24 V~	2 NO + 2 NC
1	4 162 41	4 162 51	60 kW	24 V=	2 NO + 2 NC
1	4 162 42	4 162 52	60 kW	48 V~	2 NO + 2 NC
1	4 162 43	4 162 53	60 kW	48 V=	2 NO + 2 NC
1	4 162 46	4 162 56	60 kW	100-240 V~/=	2 NO + 2 NC
1	4 162 49	4 162 59	60 kW	400-440 V~	2 NO + 2 NC
			150 A (AC3) - 210 A (AC1)		
1	4 162 60	4 162 70	75 kW	24 V~	2 NO + 2 NC
1	4 162 61	4 162 71	75 kW	24 V=	2 NO + 2 NC
1	4 162 62	4 162 72	75 kW	48 V~	2 NO + 2 NC
1	4 162 63	4 162 73	75 kW	48 V=	2 NO + 2 NC
1	4 162 66	4 162 76	75 kW	100-240 V~/=	2 NO + 2 NC
1	4 162 69	4 162 79	75 kW	400-440 V~	2 NO + 2 NC

Pack	Cat.Nos		CTX³ 225		
			With integrated auxiliary contacts		
			185 A (AC3) - 230 A (AC1)		
	Screw terminals		3-phase motor 400/415 V	Control Voltage	Integrated auxiliary contacts
1	4 162 80		90 kW	24 V~/=	2 NO + 2 NC
1	4 162 82		90 kW	48 V~/=	2 NO + 2 NC
1	4 162 86		90 kW	100-240 V~/=	2 NO + 2 NC
1	4 162 89		90 kW	380-450 V~	2 NO + 2 NC
			225 A (AC3) - 275 A (AC1)		
1	4 162 90		132 kW	24 V~/=	2 NO + 2 NC
1	4 162 92		132 kW	48 V~/=	2 NO + 2 NC
1	4 162 96		132 kW	100-240 V~/=	2 NO + 2 NC
1	4 162 99		132 kW	380-450 V~	2 NO + 2 NC
			CTX³ 400		
			With integrated auxiliary contacts		
			265 A (AC3) - 300 A (AC1)		
	Screw terminals		3-phase motor 400/415 V	Control Voltage	Integrated auxiliary contacts
1	4 163 06		147 kW	100-240 V~/=	2 NO + 2 NC
1	4 163 09		147 kW	380-450 V~	2 NO + 2 NC
			330 A (AC3) - 350 A (AC1)		
1	4 163 16		160 kW	100-240 V~/=	2 NO + 2 NC
1	4 163 19		160 kW	380-450 V~	2 NO + 2 NC
			400 A (AC3) - 450 A (AC1)		
1	4 163 26		200 kW	100-240 V~/=	2 NO + 2 NC
1	4 163 29		200 kW	380-450 V~	2 NO + 2 NC

Pack	Cat.Nos		CTX³ 800		
			With integrated auxiliary contacts		
			500 A (AC3) - 580 A (AC1)		
	Screw terminals		3-phase motor 400/415 V	Control Voltage	Integrated auxiliary contacts
1	4 163 36		265 kW	200-240 V~/=	2 NO + 2 NC
1	4 163 39		265 kW	380-450 V~	2 NO + 2 NC
			630 A (AC3) - 660 A (AC1)		
1	4 163 46		330 kW	200-240 V~/=	2 NO + 2 NC
1	4 163 49		330 kW	380-450 V~	2 NO + 2 NC
			800 A (AC3) - 900 A (AC1)		
1	4 163 56		440 kW	200-240 V~/=	2 NO + 2 NC
1	4 163 59		440 kW	380-450 V~	2 NO + 2 NC

Spare coils **p. 37**

Thermal relays RTX³

for CTX³ 3-pole industrial contactors

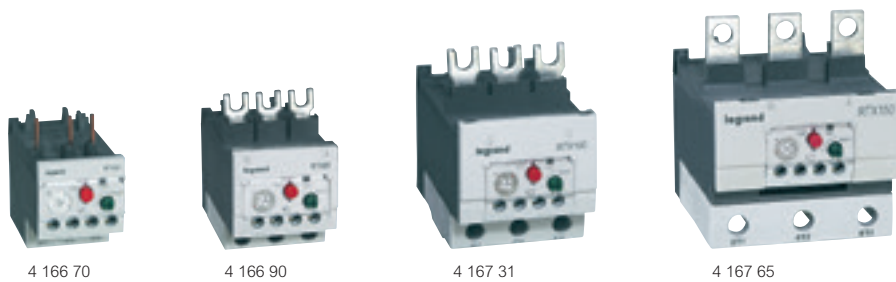

Dimensions **p. 42-43**
 Tripping curves **p. 46-49**

Thermal protection against overloads, long starting times and lasting stalling of the motor
 Differential type ensures a better protection in case of one phase failure thanks to faster tripping
 Conform to IEC 60 947-1, IEC 60 947-4-1

Pack	Cat. Nos		Adjustment range	
	standard	diff.	I min. (A)	I max. (A)
Thermal overload relays				
Class 10A Integrated auxiliary contacts 1 NO + 1 NC				
RTX³ 40				
For CTX ³ 22 and 40 With screw terminals				
	Type			
1	4 166 40	4 166 60	0.1	0.16
1	4 166 41	4 166 61	0.16	0.25
1	4 166 42	4 166 62	0.25	0.4
1	4 166 43	4 166 63	0.4	0.63
1	4 166 44	4 166 64	0.63	1
1	4 166 45	4 166 65	1	1.6
1	4 166 46	4 166 66	1.6	2.5
1	4 166 47	4 166 67	2.5	4
1	4 166 48	4 166 68	4	6
1	4 166 49	4 166 69	5	8
1	4 166 50	4 166 70	6	9
1	4 166 51	4 166 71	7	10
1	4 166 52	4 166 72	9	13
1	4 166 53	4 166 73	12	18
1	4 166 54	4 166 74	16	22
1	4 166 55	4 166 75	18	25
1	4 166 56	4 166 76	22	32
1	4 166 57	4 166 77	28	40
RTX³ 65				
For CTX ³ 65 Standard type with screw terminals Differential type with cage terminals				
1	4 166 83	4 167 03	9	13
1	4 166 84	4 167 04	12	18
1	4 166 85	4 167 05	16	22
1	4 166 86	4 167 06	18	25
1	4 166 87	4 167 07	24	36
1	4 166 88	4 167 08	28	40
1	4 166 89	4 167 09	34	50
1	4 166 90	4 167 10	45	65

Pack	Cat. Nos		Adjustment range		I max. (A)
	standard	diff.	I min. (A)	I max. (A)	
Thermal overload relays (continued)					
Class 10A Integrated auxiliary contacts 1 NO + 1 NC					
RTX³ 100					
For CTX ³ 100 Standard type with screw terminals Differential type with cage terminals					
	Type				
1	4 167 23	4 167 43	18		25
1	4 167 24	4 167 44	24		36
1	4 167 25	4 167 45	28		40
1	4 167 26	4 167 46	34		50
1	4 167 27	4 167 47	45		65
1	4 167 28	4 167 48	54		75
1	4 167 29	4 167 49	63		85
1	4 167 30	4 167 50	70		95
1	4 167 31	4 167 51	80		100
RTX³ 150					
For CTX ³ 150 Standard type with screw terminals Differential type with cage terminals					
1	4 167 60	4 167 70	45		65
1	4 167 61	4 167 71	54		75
1	4 167 62	4 167 72	63		85
1	4 167 63	4 167 73	80		105
1	4 167 64	4 167 74	95		130
1	4 167 65	4 167 75	110		150
Separate mounting units					
To mount the relays separately from contactors, on DIN rail or panel by fixing screws					
1	4 165 91		For RTX ³ 40 up to 32 A		
1	4 165 92		For RTX ³ 40 40 A		
1	4 165 93		For RTX ³ 65 with screw terminals		
1	4 165 94		For RTX ³ 65 with cage terminals		
1	4 165 95		For RTX ³ 100 with screw terminals		
1	4 165 96		For RTX ³ 100 with cage terminals		
1	4 165 97		For RTX ³ 150 with screw terminals		
1	4 165 98		For RTX ³ 150 with cage terminals		



Thermal relays RTX³

for CTX³ 3-pole industrial contactors

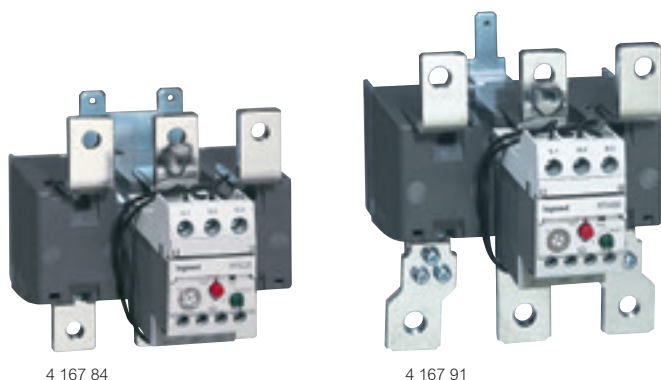

4 167 84

4 167 91

Dimensions p. 42-43
Tripping curves p. 46-49

Conform to IEC 60 947-1, IEC 60 947-4-1

Pack	Cat. Nos	Thermal overload relays		
		Class 10A Integrated auxiliary contacts 1 NO + 1 NC		
		RTX³ 225		
		For CTX ³ 225 With screw terminals		
		Type diff	Adjustment range	
		I min. (A)		I max. (A)
1	4 167 80	65		100
1	4 167 81	85		125
1	4 167 82	100		160
1	4 167 83	120		185
1	4 167 84	160		240
		RTX³ 400		
		For CTX ³ 400 With screw terminals		
1	4 167 86	85		125
1	4 167 87	100		160
1	4 167 88	120		185
1	4 167 89	160		240
1	4 167 90	200		330
1	4 167 91	260		400
		RTX³ 800		
		For CTX ³ 800 With screw terminals		
1	4 167 92	200		300
1	4 167 93	260		400
1	4 167 94	400		600
1	4 167 95	520		800

4-pole contactors CTX³

40 A to 900 A industrial contactors and spare coils

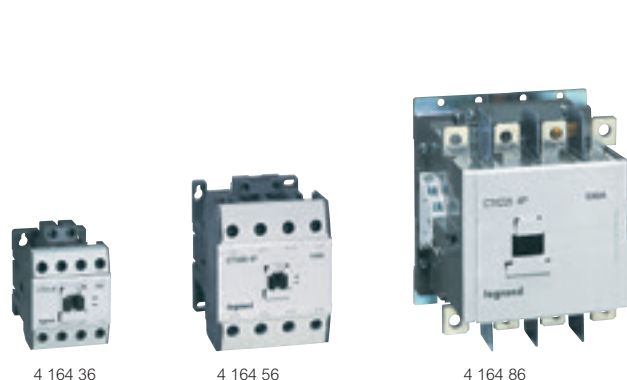

4 164 36

4 164 56

4 164 86

Dimensions p. 44-45

Conform to IEC 60 947-1, IEC 60 947-4-1
Can be equipped with add-on auxiliary contact blocks, time delay blocks (except CTX³ 4P from 165 A to 900 A), and CTX³ interlocking

Pack	Cat. Nos	Contactors CTX ³		
		Power terminals: screw terminals		
		Without integrated auxiliary contact		
		Max. operating current AC-1	Max. operating current AC-3	Control Voltage
1	4 164 26	40 A	22 A	230 V~
1	4 164 36	60 A	40 A	230 V~
1	4 164 46	100 A	65 A	230 V~
1	4 164 56	135 A	85 A	230 V~
		With integrated auxiliary contacts		
		Auxiliary contacts: 2 NO + 2 NC		
1	4 164 66	165 A	130 A	100-240 V~/=
1	4 164 76	250 A	150 A	100-240 V~/=
1	4 164 86	330 A	225 A	100-240 V~/=
1	4 164 96	420 A	330 A	100-240 V~/=
1	4 165 06	500 A	400 A	100-240 V~/=
1	4 165 16	750 A	630 A	200-240 V~/=
1	4 165 26	900 A	800 A	200-240 V~/=
		Spare coils for CTX³ 4P contactors		
		Control voltage 230 V~		
1	4 165 46	For CTX ³ 40 A to 60 A (AC-1)		
1	4 165 56	For CTX ³ 100 A to 135 A (AC-1)		
1	4 165 66	For CTX ³ 165 A to 330 A (AC-1)		
1	4 165 76	For CTX ³ 420 A to 500 A (AC-1)		
1	4 165 86	For CTX ³ 750 A to 900 A (AC-1)		

Mechanical interlocks
p. 36



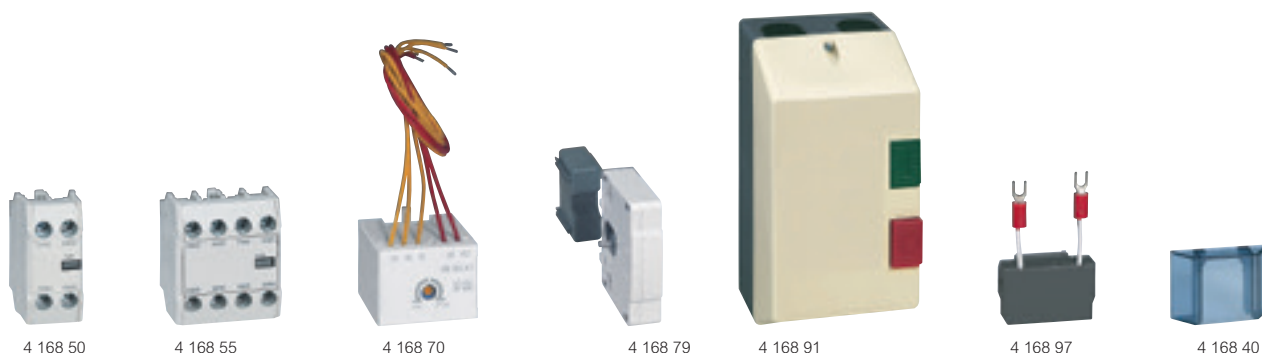

Technical characteristics **p. 38-39**
 Dimensions **p. 39**

Pack Cat. Nos CTX³ add-on auxiliary contact blocks

Pack	Cat. Nos	CTX ³ add-on auxiliary contact blocks
		Front mounting
		For CTX ³ 3P from 9 A to 150 A (AC-3) and CTX ³ 4P from 40 A to 135 A (AC-1)
		2 and 4 pole
		Ith: 16 A
20	4 168 50	1 NO + 1 NC
20	4 168 51	2 NO
20	4 168 52	2 NC
10	4 168 53	4 NO
10	4 168 54	3 NO + 1 NC
10	4 168 55	2 NO + 2 NC
10	4 168 56	1 NO + 3 NC
10	4 168 57	4 NC
		Side mounting
		2-pole
		Mounting on both sides
1	4 168 58	For CTX ³ 3P form 9 A to 150 A (AC-3)
		1 NO + 1 NC - Ith: 16 A
1	4 168 59	For CTX ³ 3P form 185 A to 800 A (AC-3) and CTX ³ 4P from 165 A to 900 A (AC-1)
		1 NO + 1 NC - Ith: 16 A
1	4 168 49	For CTX ³ 4P from 40 A to 135 A (AC-1)
		1 NO + 1 NC - Ith: 16 A

CTX³ time delay blocks

Pack	Cat. Nos	CTX ³ time delay blocks
		For CTX ³ 3P form 9 A to 150 A (AC-3)
		Time delay: 1 to 30 s
		Front mounting
		On delay
1	4 168 70	24-48 V~/=
1	4 168 71	110-230 V~/=
		Off delay
1	4 168 72	24-48 V~/=
1	4 168 73	110-230 V~/=

CTX³ capacitor switching units

Pack	Cat. Nos	CTX ³ capacitor switching units
		AC-6b
		Operating power from 9.7 kVAR to 62 kVAR (400/440 V)
1	4 168 74	For contactors CTX ³ 3P from 9 to 40 A
1	4 168 75	For contactors CTX ³ 3P 50 and 65 A with screw terminals
1	4 168 76	For contactors CTX ³ 3P 50 to 100 A with cage terminals
1	4 168 77	For contactors CTX ³ 3P 75 to 100 A with screw terminals

Pack Cat. Nos CTX³ interlocking

Pack	Cat. Nos	CTX ³ interlocking
		Component parts for assembling by customer
		Horizontal mounting
		Interlock units
1	4 168 79	Mechanical interlocks for CTX ³ 4P from 40 to 135 A (AC-1) (p. 35)
1	4 168 80	Mechanical interlocks for CTX ³ 3P from 9 to 150 A (p. 32-33)
		Provides 2 NC contacts for use in electrical interlocking
1	4 168 87	Mechanical interlocks for CTX ³ 3P from 185 to 400 A and CTX ³ 4P from 165 to 500 A (p. 33 and 35)
1	4 168 88	Mechanical interlocks for CTX ³ 3P from 500 to 800 A (p. 33)
1	4 168 89	Mechanical interlocks for CTX ³ 4P from 750 to 900 A (p. 35)
		Wire kits
		Used for making reversing between two 3P contactors (varistors)
4	4 168 82	For CTX ³ 22
6	4 168 83	For CTX ³ 40
2	4 168 84	For CTX ³ 65
1	4 168 85	For CTX ³ 100

Boxes for motor starter

Pack	Cat. Nos	Boxes for motor starter
		For CTX ³ 22 equipped with RTX ³ 40 (0.1 - 22 A)
1	4 168 90	Without pushbuttons
1	4 168 91	With pushbuttons

CTX³ transient voltage suppressor blocks

Pack	Cat. Nos	CTX ³ transient voltage suppressor blocks
		Absorbs the surge arisen out of the coil of the contactor (varistors)
10	4 168 95	24-48 V~/=
10	4 168 96	100-125 V~/=
10	4 168 97	200-240 V~/=
10	4 168 98	380-400 V~/=

CTX³ terminals covers

Pack	Cat. Nos	CTX ³ terminals covers
1	4 168 42	For CTX ³ 3P from 185 to 225 A (AC-3)
1	4 168 43	For CTX ³ 3P from 265 to 400 A (AC-3)
1	4 168 44	For CTX ³ 3P from 500 to 900 A (AC-3)
1	4 168 45	For CTX ³ 4P from 165 to 330 A (AC-1)
1	4 168 46	For CTX ³ 4P from 420 to 500 A (AC-1)
1	4 168 47	For CTX ³ 4P from 750 to 900 A (AC-1)

CTX³ safety front cover

Pack	Cat. Nos	CTX ³ safety front cover
150	4 168 40	For CTX ³ 3P from 9 to 150 A (AC-3) and CTX ³ 4P from 40 to 135 A (AC-1)
150	4 168 41	For CTX ³ 3P from 85 to 800 A (AC-3) and CTX ³ 4P from 165 to 900 A (AC-1)

Distant reset flexible cables for thermal relays

Pack	Cat. Nos	Distant reset flexible cables for thermal relays
1	4 168 92	400 mm
1	4 168 93	500 mm
1	4 168 94	600 mm

CTX³ spare coils

Control relays CTX³



4 169 66



4 168 10

Dimensions p. 31

Pack Cat. Nos Spare coils for CTX³ 3P contactors

Pack	Cat. Nos	Spare coils for CTX ³ 3P contactors
		For CTX³ 22
1	4 169 00	24 V~
1	4 169 02	48 V~
1	4 169 04	110 V~
1	4 169 06	230 V~
1	4 169 08	380 V~
1	4 169 09	415 V~
		For CTX³ 40
1	4 169 20	24 V~
1	4 169 21	24 V=
1	4 169 22	48 V~
1	4 169 23	48 V=
1	4 169 24	110 V~
1	4 169 26	230 V~
1	4 169 28	380 V~
1	4 169 29	415 V~
		For CTX³ 65
1	4 169 30	24 V~
1	4 169 31	24 V=
1	4 169 32	48 V~
1	4 169 33	48 V=
1	4 169 34	110 V~
1	4 169 36	230 V~
1	4 169 38	380 V~
1	4 169 39	415 V~
		For CTX³ 100
1	4 169 40	24 V~
1	4 169 41	24 V=
1	4 169 42	48 V~
1	4 169 43	48 V=
1	4 169 44	110 V~
1	4 169 46	230 V~
1	4 169 48	380 V~
1	4 169 49	415 V~
		For CTX³ 150
1	4 169 50	24 V~
1	4 169 51	24 V=
1	4 169 52	48 V~
1	4 169 53	48 V=
1	4 169 56	100-240 V~/=
1	4 169 59	400-440 V~
		For CTX³ 225
1	4 169 60	24 V~/=
1	4 169 62	48 V~/=
1	4 169 66	100-240 V~/=
1	4 169 69	400-440 V~
		For CTX³ 400
1	4 169 76	100-240 V~/=
1	4 169 79	380-450 V~
		For CTX³ 800
1	4 169 86	200-240 V~/=
1	4 169 89	380-450 V~

Pack Cat. Nos CTX³ control relays

Pack	Cat. Nos	CTX ³ control relays
		4-pole Conform to IEC 60 947-1 and IEC 60 947-4-1 for the auxiliary contacts Can be equipped with CTX ³ mini I _{th} = 10 A Low consumption coil
		4 NO
1	4 168 00	24 V~
1	4 168 01	24 V=
1	4 168 02	48 V~
1	4 168 03	48 V=
1	4 168 04	110 V~
1	4 168 06	230 V~
1	4 168 09	400 V~
		3 NO + 1 NC
1	4 168 10	24 V~
1	4 168 11	24 V=
1	4 168 12	48 V~
1	4 168 13	48 V=
1	4 168 14	110 V~
1	4 168 16	230 V~
1	4 168 19	400 V~
		2 NO + 2 NC
1	4 168 20	24 V~
1	4 168 21	24 V=
1	4 168 22	48 V~
1	4 168 23	48 V=
1	4 168 24	110 V~
1	4 168 26	230 V~
1	4 168 29	400 V~

Contactors CTX³

technical characteristics

Environmental conditions

- Storage temperature: -50 °C to +40 °C
- Operating temperature: -5 °C to +40 °C
- Operating altitude: 3000 m
- Protection degree: IP 20
- Shock resistance: open 8 G / closed 10 G
- Vibration resistance (5-300 Hz): open 2 G / closed 4 G

Type 2 coordination with MPCBs MPX³

According to IEC 60947-4-1
Short circuit current I_q = 50 kA Voltage 400/415 V~ 50/60 Hz

Standard motors AC-3 at 400/415 V 1500 rpm		Manual motor starter			Magnetic release response current (A)	Contactor	
Rated Power (kW)	Current (A)	MPCB type Type	Rating (A)	Thermal overload release setting range (A)		Type	Rating (A)
-	-	MPX ³ 32S	0.16	0.1 - 0.16	2.08	CTX ³ 22	9
0.06	0.20	MPX ³ 32S	0.25	0.16 - 0.25	3.25	CTX ³ 22	9
0.09	0.30	MPX ³ 32S	0.40	0.25 - 0.4	5.2	CTX ³ 22	9
0.12	0.40	MPX ³ 32S	0.63	0.4 - 0.63	8.19	CTX ³ 22	9
0.18	0.60	MPX ³ 32S	0.63	0.4 - 0.63	8.19	CTX ³ 22	9
0.25	0.80	MPX ³ 32S	1	0.63 - 1	13	CTX ³ 22	9
0.37	1.1	MPX ³ 32S	1.6	1 - 1.6	20.8	CTX ³ 22	9
0.55	1.5	MPX ³ 32S	1.6	1 - 1.6	20.8	CTX ³ 22	9
0.75	1.9	MPX ³ 32S	2.5	1.6 - 2.5	32.5	CTX ³ 22	12
1.1	2.7	MPX ³ 32S	4	2.5 - 4	52	CTX ³ 22	18
1.5	3.6	MPX ³ 32S	4	2.5 - 4	52	CTX ³ 22	18
2.2	5.2	MPX ³ 32S	6	4 - 6	78	CTX ³ 22	18
3	6.8	MPX ³ 32S	8	5 - 8	104	CTX ³ 22	18
4	9	MPX ³ 32S	10	6 - 10	130	CTX ³ 22	18
5.5	11.5	MPX ³ 32H	13	9 - 13	169	CTX ³ 22	22
7.5	15.5	MPX ³ 32H	17	11 - 17	221	CTX ³ 22	22
10	20	MPX ³ 32H	22	14 - 22	286	CTX ³ 40	32
11	22	MPX ³ 32H	25	18 - 26	338	CTX ³ 40	32
15	29	MPX ³ 32H	32	22 - 32	416	CTX ³ 40	32
18.5	35	MPX ³ 63H	40	28 - 40	520	CTX ³ 65	50
22	41	MPX ³ 63H	50	34 - 50	650	CTX ³ 65	50
30	55	MPX ³ 63H	63	45 - 63	819	CTX ³ 65	65
37	67	MPX ³ 100H	75	55 - 75	975	CTX ³ 100	75
-	-	MPX ³ 100H	90	70 - 90	1170	CTX ³ 100	85
45	80	MPX ³ 100H	100	80 - 100	1300	CTX ³ 100	85

Definition type 2 coordination according to IEC 947-4-1:

- The contactor or the starter must not endanger persons or systems in the event of a short-circuit.
- The contactor or the starter must be suitable for further use.
- No damage to the overload relay or other parts may occur with the exception of welding of the contactor or starter contacts provided that these can be easily separated without significant deformation (such as with a screwdriver).

Accessory

Interlock unit, Cat.No 4 168 80

The mechanical interlock unit provides 2NC contacts for use in electrical interlocking of two contactors

Wire kits

Used for making reversing circuit between two contactors

Contactor	Wire kit		Interlock unit	
	Cat.No	Weight	Cat.No	Weight
CTX ³ 22	4 168 82	0.04 kg	4 168 80	0.06 kg
CTX ³ 40	4 168 83	0.05 kg		
CTX ³ 65	4 168 84	0.12 kg		
CTX ³ 100	4 168 85	0.33 kg		
CTX ³ 150	-	-		

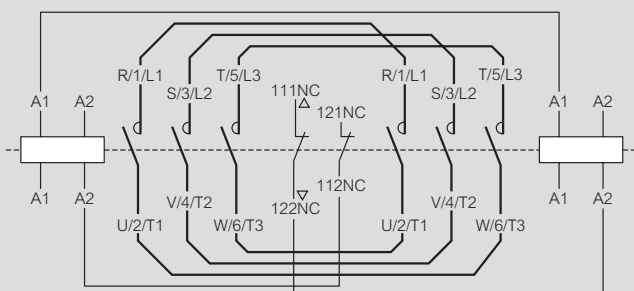

CTX³ 9 A - 150 A typical circuit diagram for reversing contactor

Rating of the contacts in the interlocks

Rated operation voltage (V)	600
Rated insulation voltage (V)	600
Rated frequency (Hz)	50/60
Rated thermal current (A)	10
Rated operation current (A) 240 V AC-15	3

Time delay blocks Cat.Nos 4 168 70/71/72/73

Applying contactors	Cat.No	Rated voltage	Performance
CTX ³ 22 to CTX ³ 150	On delay	4 168 70 AC/DC 24 to 48 V	<ul style="list-style-type: none"> • Mounting: Head on • Contact: 1 NC • Time delay: 1s to 30s On delay, Off delay
		4 168 71 AC 110 to 230 V	
Off delay		4 168 72 AC/DC 24 to 48 V	<ul style="list-style-type: none"> • Frequency: AC 50/60 hz • Operation: Min. voltage 85% Max. voltage 110% • Accuracy of setting time: ± 20 %
		4 168 73 AC 110 to 230 V	

■ CTX³ capacitor switching units Cat.Nos 4 168 74/75/76/77

Capacitor unit is connected to the terminals of the contactor to reduce the high inrush current.
IEC 60947-4-1 AC 6b

Type	Contactor		Maximum operating power (kvar)			Max. Peak current (A)
			220 - 240 V	400 - 440 V	500 - 550 V	
4 168 74	CTX ³ 22	9 A	5	9.7	14	560
	CTX ³ 22	12 A	6.7	12.5	18	560
	CTX ³ 22	18 A	8.5	16.7	24	850
	CTX ³ 22	22 A	10	18	26	1250
	CTX ³ 40	32 A	15	25	36	1900
4 168 75/76	CTX ³ 40	40 A	20	33.3	48	2160
	CTX ³ 65	50 A	20	40	58	2160
4 168 76/77	CTX ³ 65	65 A	25	45.7	66	3040
	CTX ³ 100	75 A	29.7	54	78	3040
	CTX ³ 100	85 A	35	60	92	3040
	CTX ³ 100	100 A	37	62	94	3040

Note: - When the switch is closed capacitor must be discharged before recharged. (Maximum residual voltage at terminals ≤ 50 V)
- To prevent short current, gG type fuse must be 1.5 - 2 times than rated current

Features of capacitor unit (Pre-loading resistor)

- Damping resistor that can limit the inrush current up to $60 \times I_n$ by closing earlier than the main contacts of the contactor
- No heat loss by the serial resistor
- Eliminates the switching surge
- Improves the performance of the capacitor system

Operation sequence

Capacitor unit: OFF
Contactor: OFF

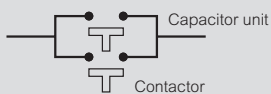

Fig.1

Capacitor unit: ON
Contactor: OFF

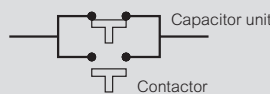

Fig.2

Capacitor unit: OFF
Contactor: ON

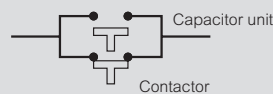
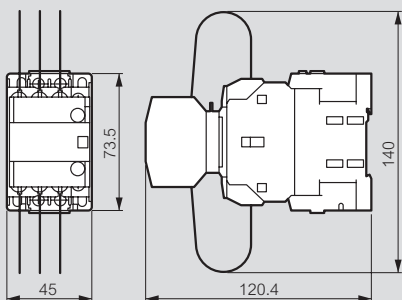

Fig.3

Note - Closing sequence: Fig.1 => Fig.2 => Fig.3
Opening sequence: Fig.3 => Fig.1

Overall dimensions of contactors equipped with CTX³ switching units

Cat.No 4 168 74 on CTX³ 22



Cat.No 4 168 75/76 on CTX³ 65

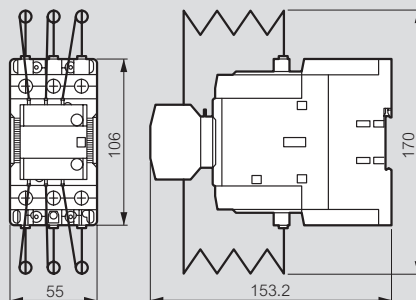

Cat.No 4 168 74 on CTX³ 40

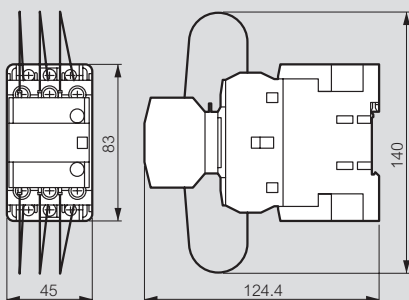

Cat.No 4 168 76/77 on CTX³ 100

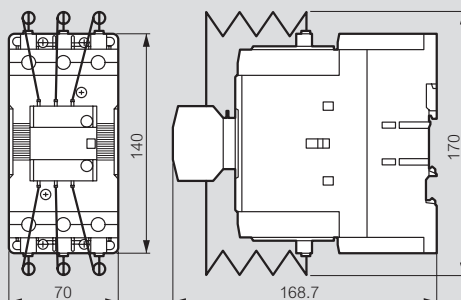

3-pole contactors CTX³

dimensions

CTX³ 22

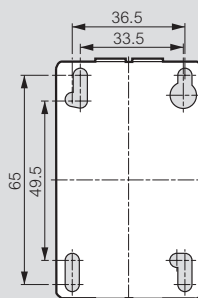
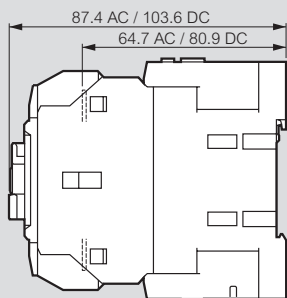
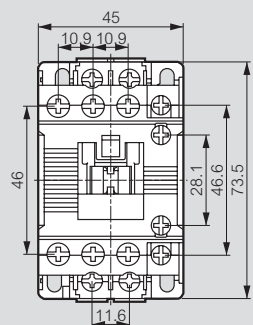

CTX³ 40

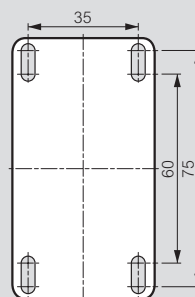
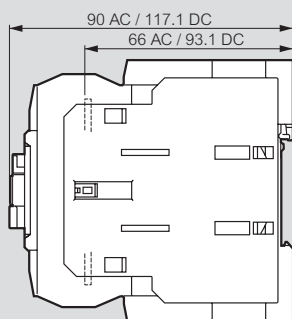
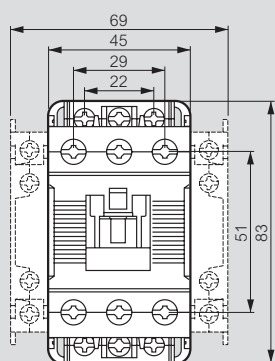

CTX³ 65

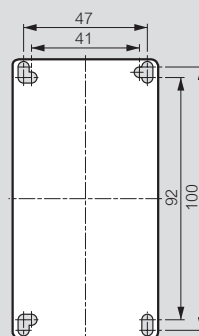
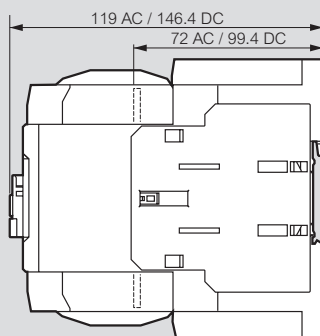
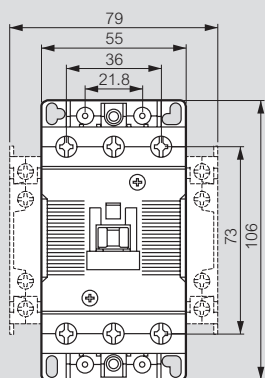

CTX³ 100

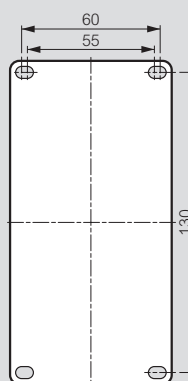
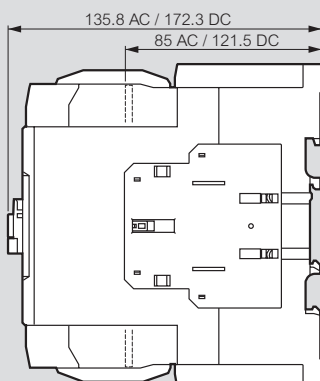
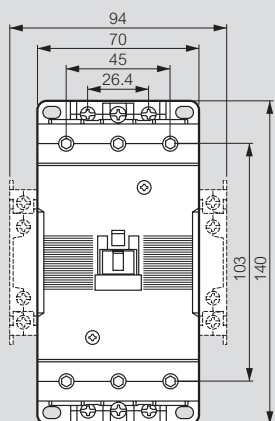

CTX³ 150

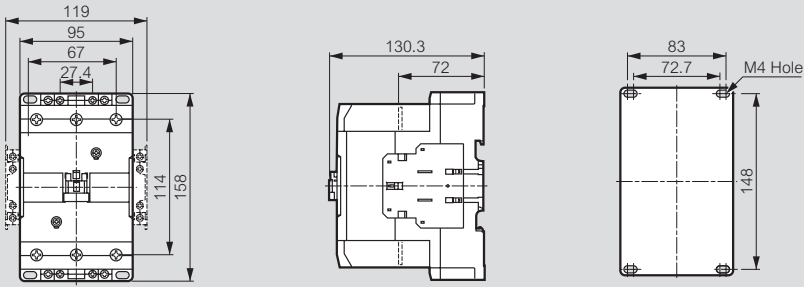

CTX³ 225

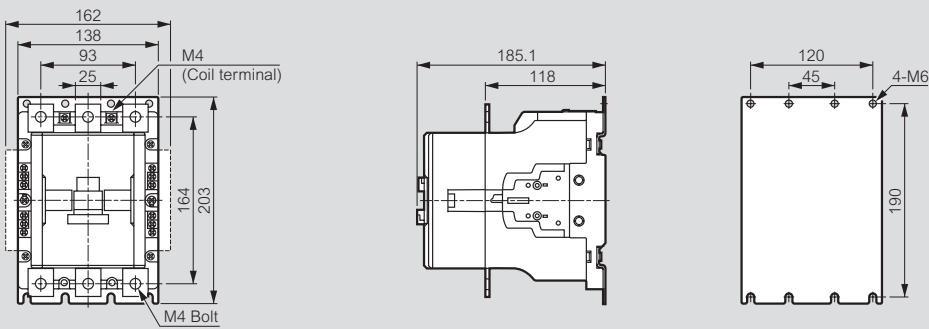

CTX³ 400

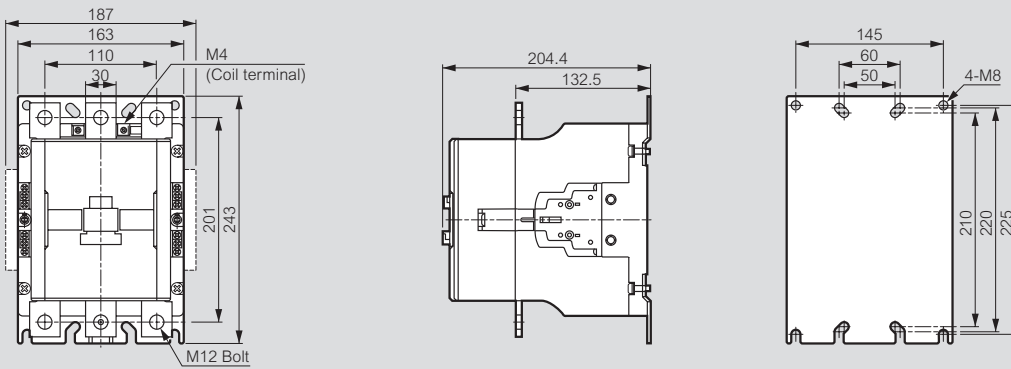

CTX³ 800

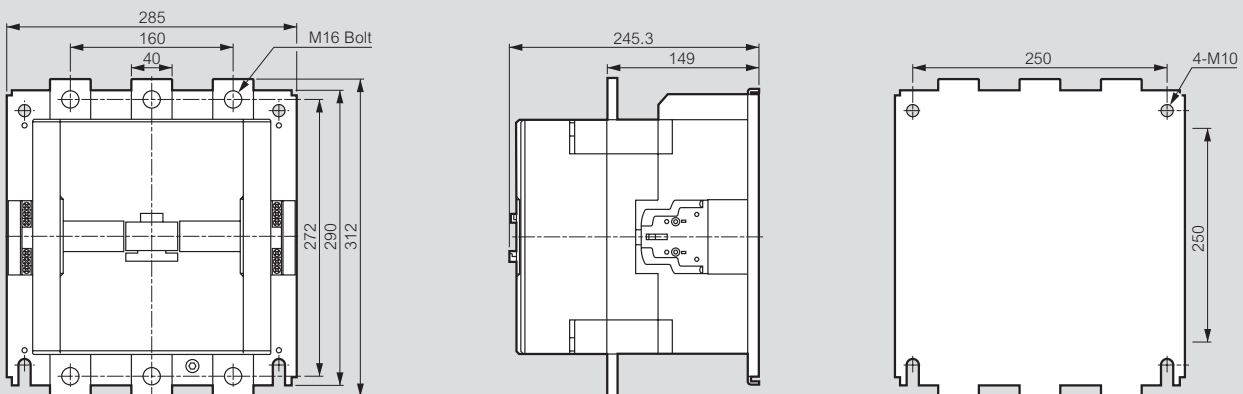

Thermal relays RTX³ - screw type terminals and cage terminals

dimensions

RTX³ 40

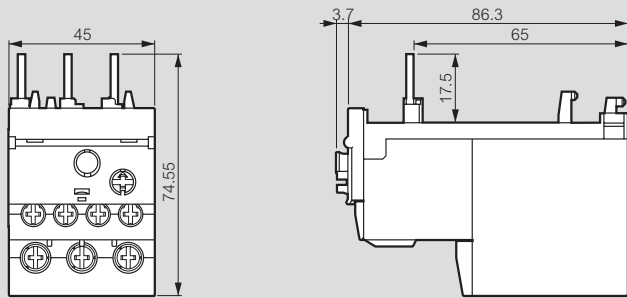

RTX³ 65

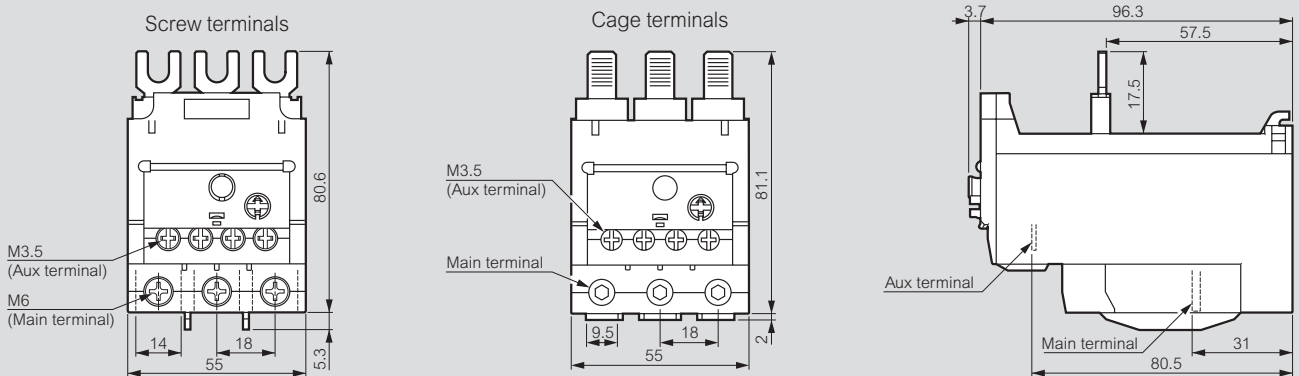

RTX³ 100

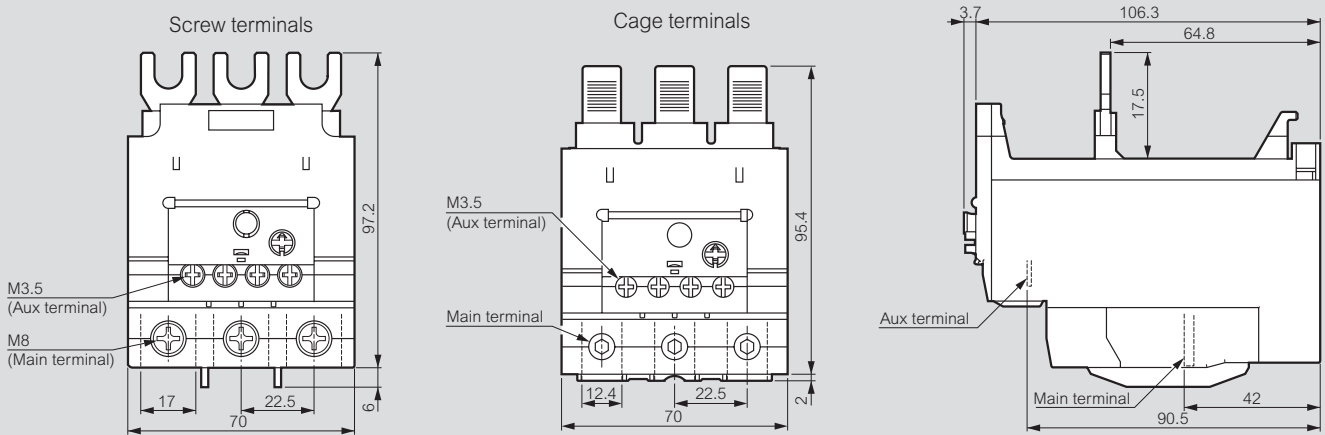

RTX³ 150

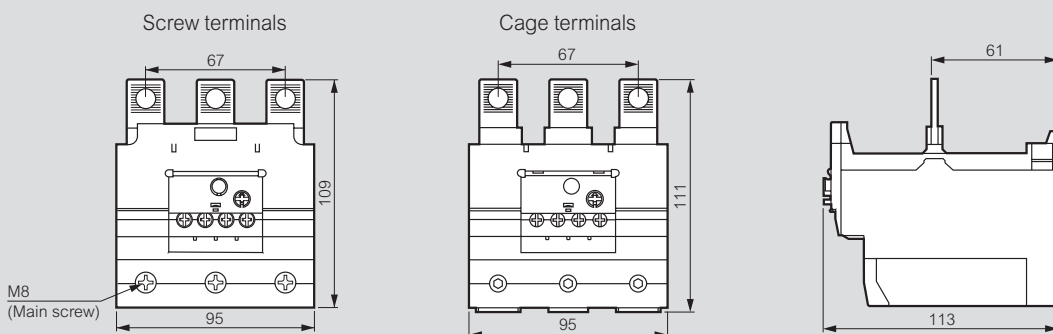

■ RTX³ 225

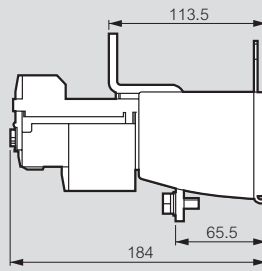
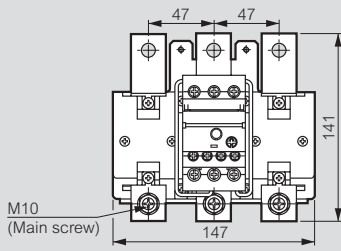

■ RTX³ 400

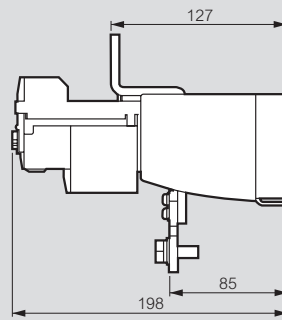
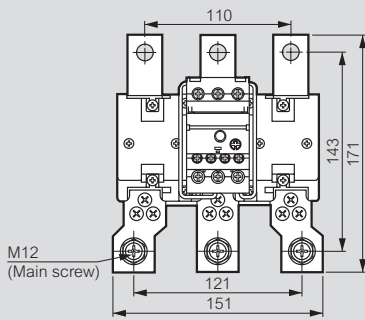

■ RTX³ 800

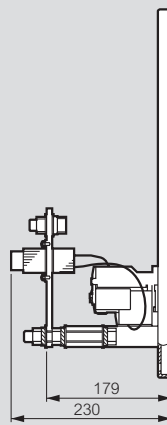
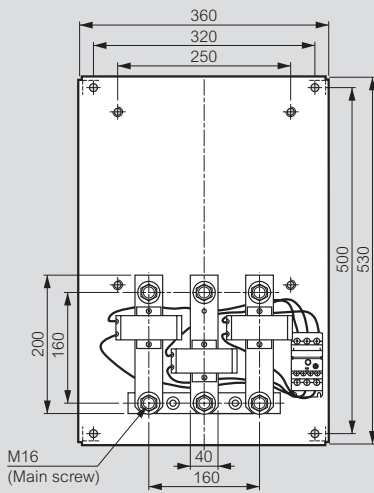

4-pole contactors CTX³

dimensions

CTX³ 4P 40 A

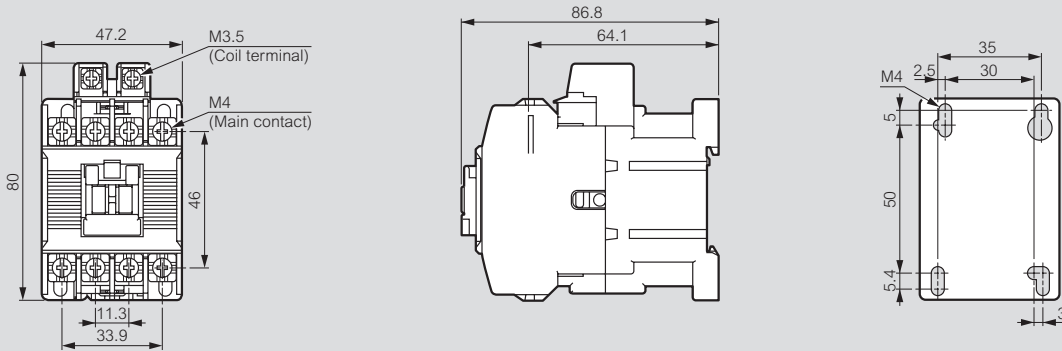

CTX³ 4P 60 A

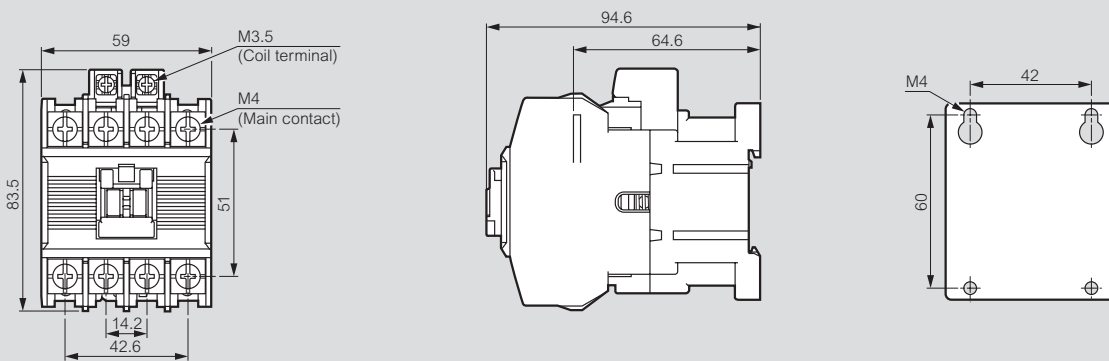

CTX³ 4P 100 A and 135 A

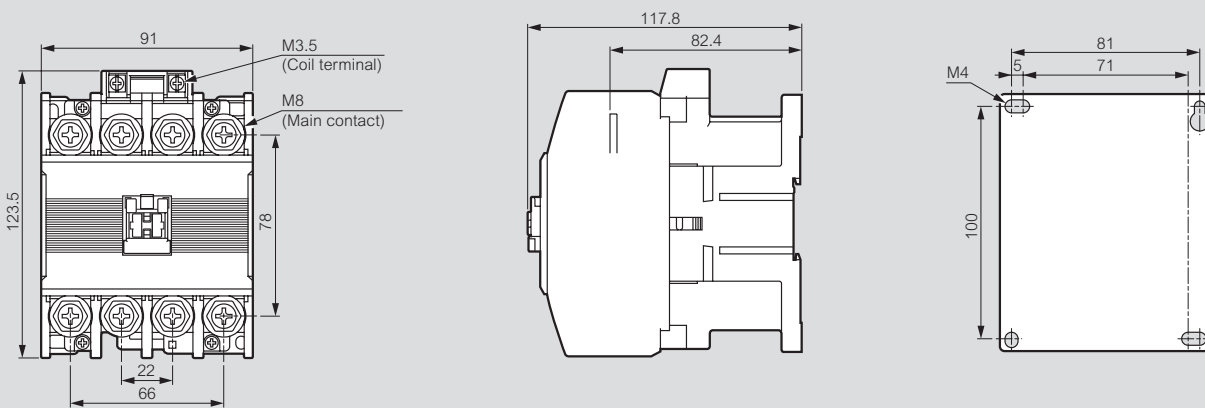

CTX³ 4P 165 A, 250 A and 330 A

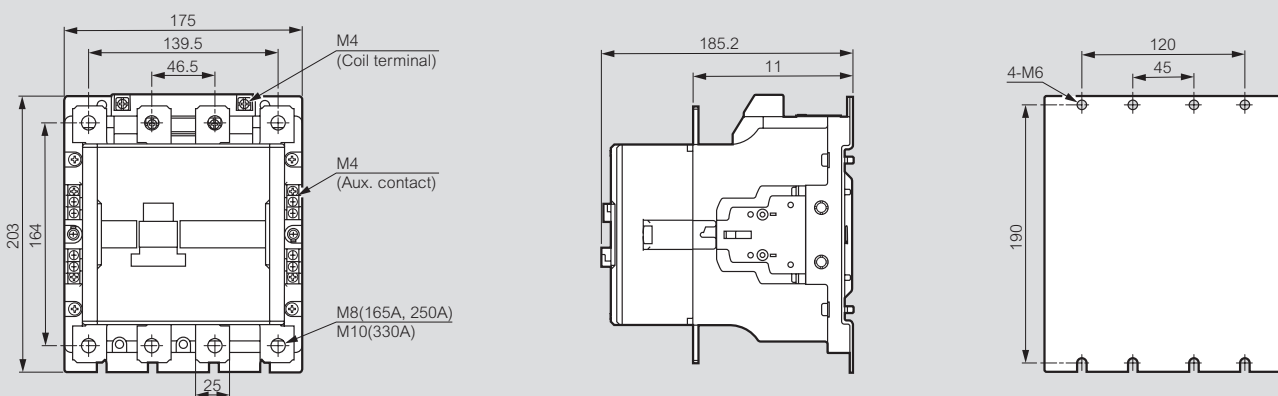

CTX³ 4P 420 A and 500 A

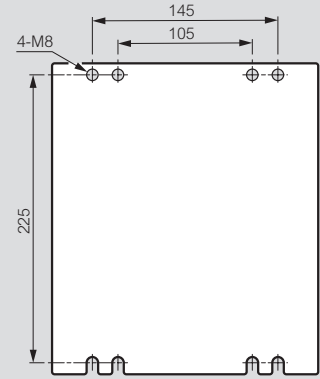
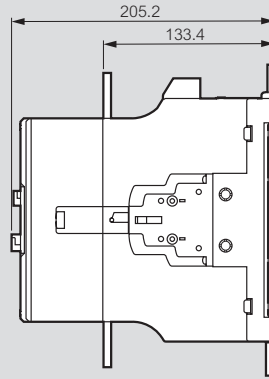
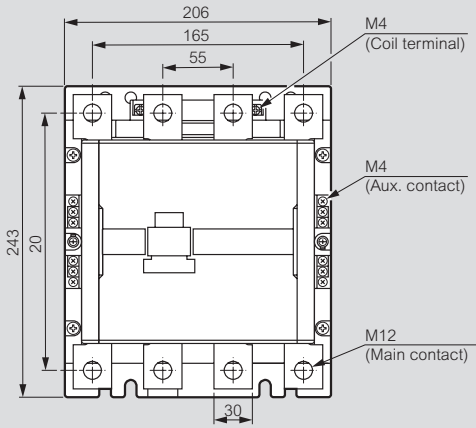

CTX³ 4P 750 A and 900 A

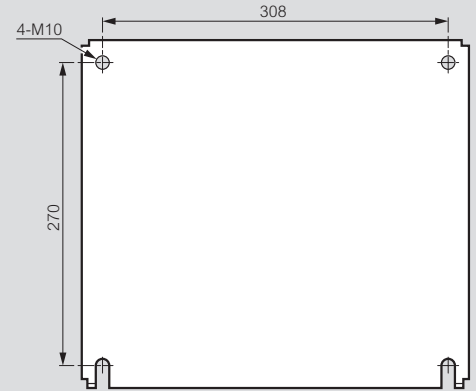
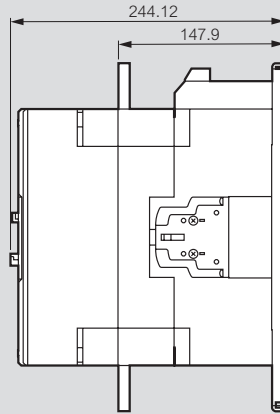
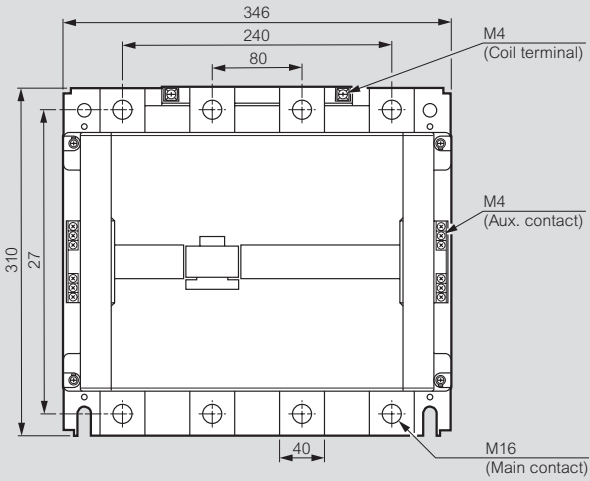

Thermal relays RTX³

tripping curves

RTX³ 40 - class 10A

Cold starting

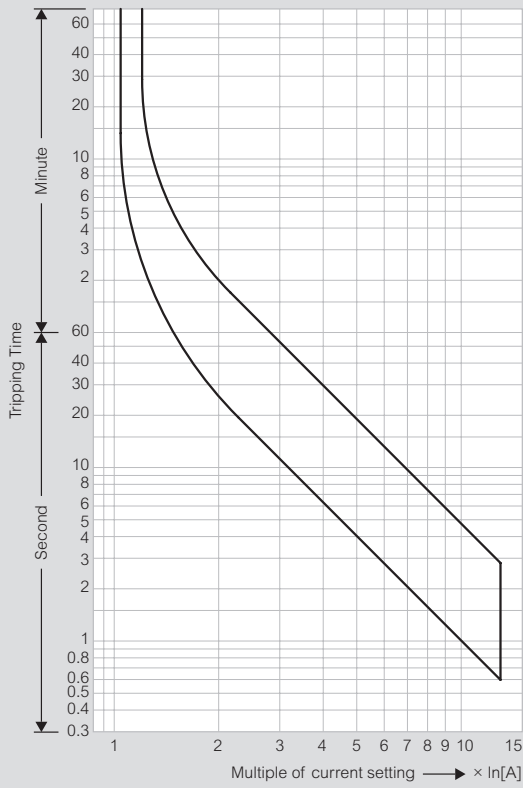

Hot starting

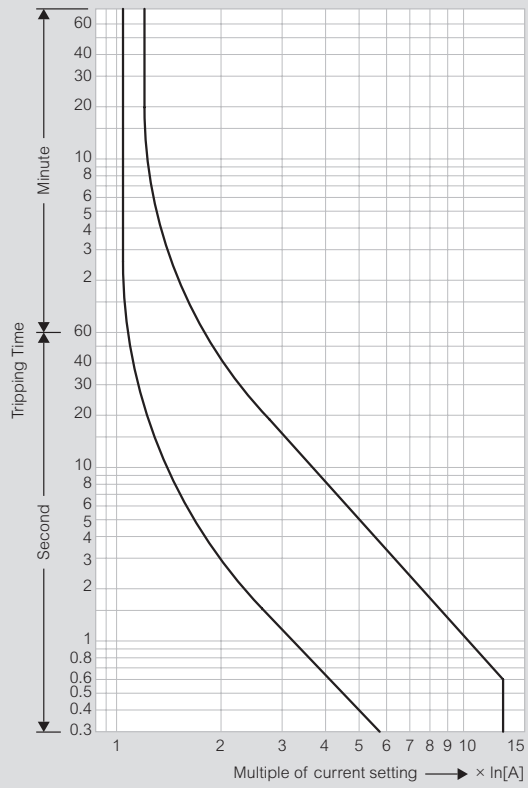

RTX³ 65 - class 10A

Cold starting

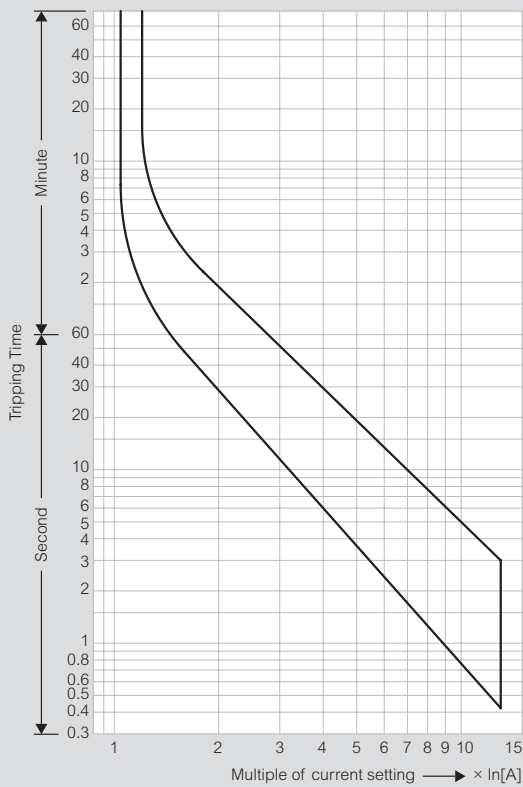

Hot starting

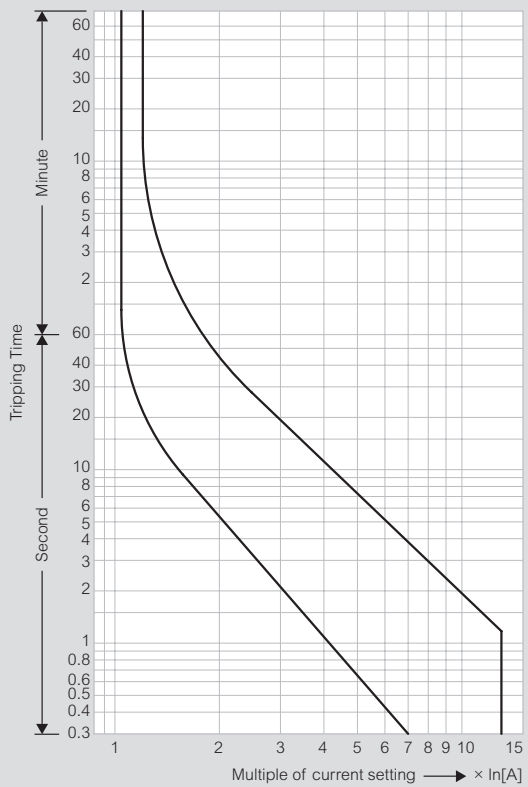

RTX³ 100 - class 10A

Cold starting

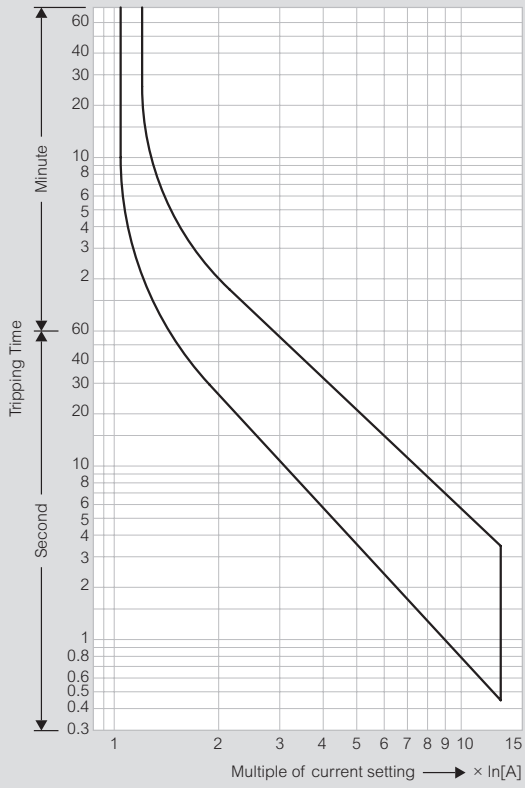

Hot starting

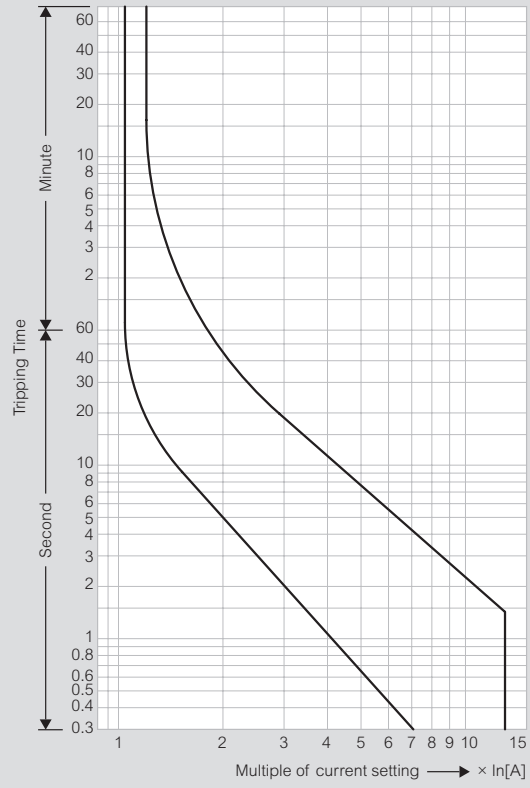

RTX³ 150 - class 10A

Cold starting

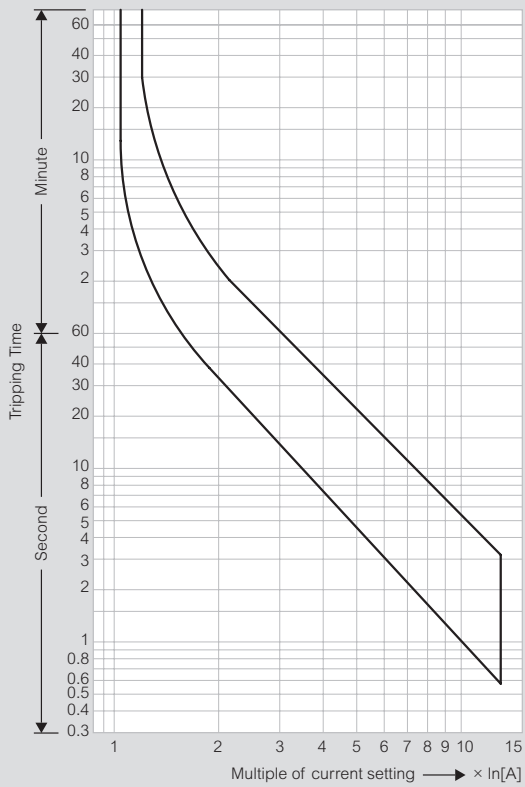

Hot starting

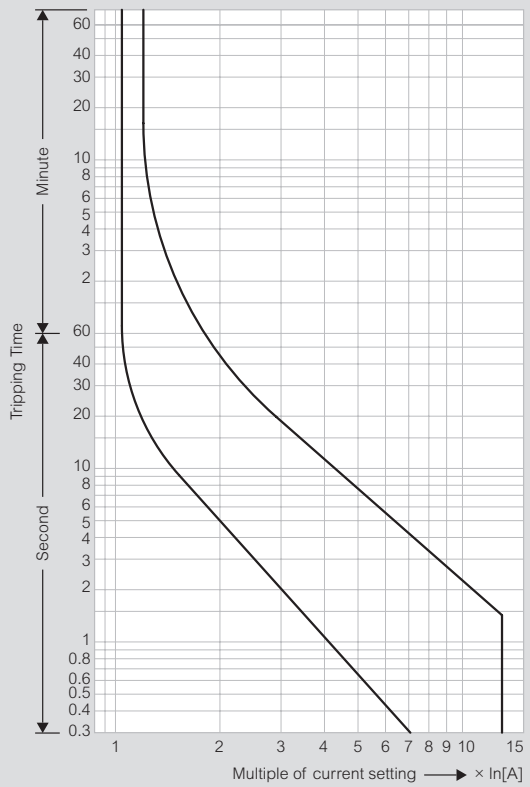

Thermal relays RTX³

tripping curves (continued)

RTX³ 225 - class 10A

Cold starting

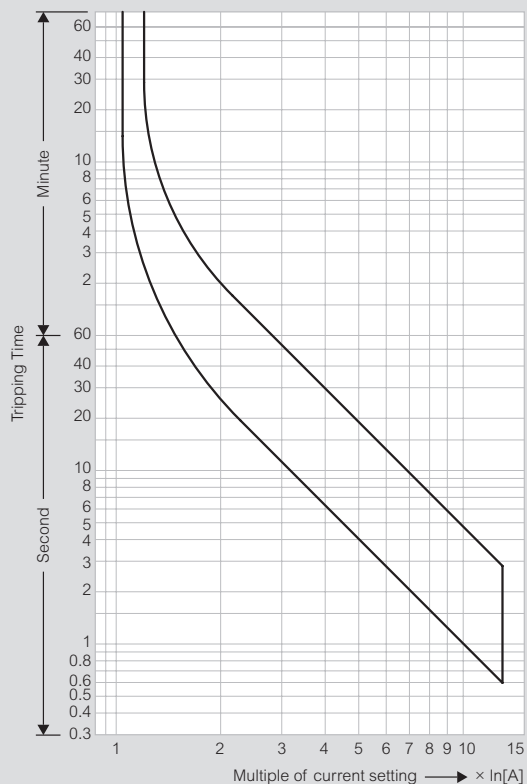

Hot starting

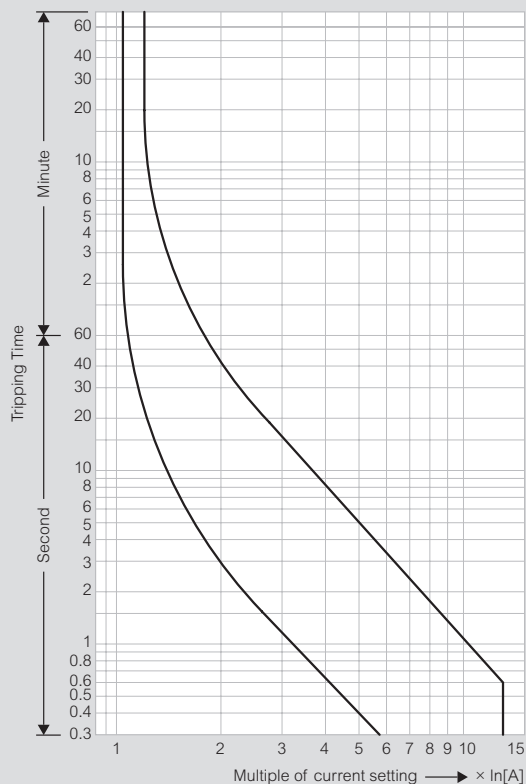

RTX³ 400 - class 10A

Cold starting

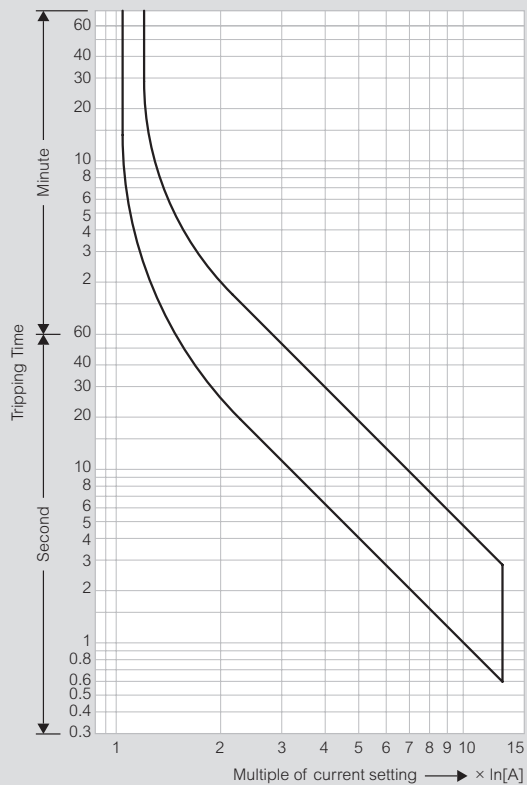

Hot starting

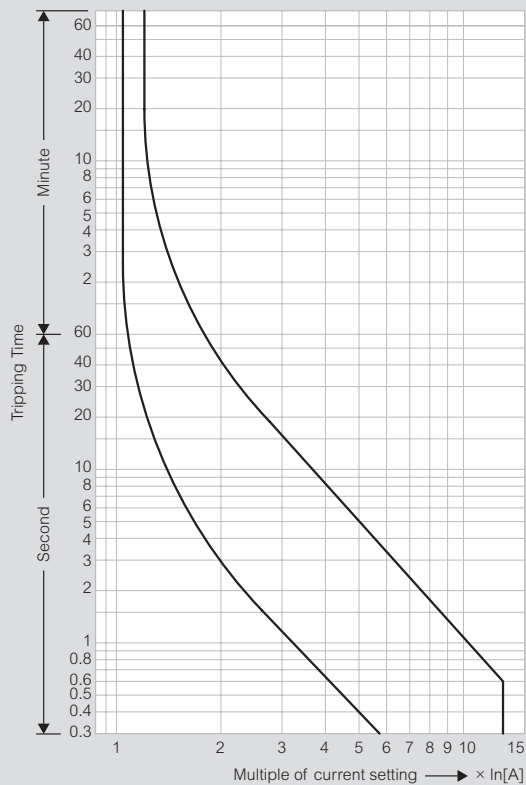

RTX³ 800 - class 10A

Cold starting

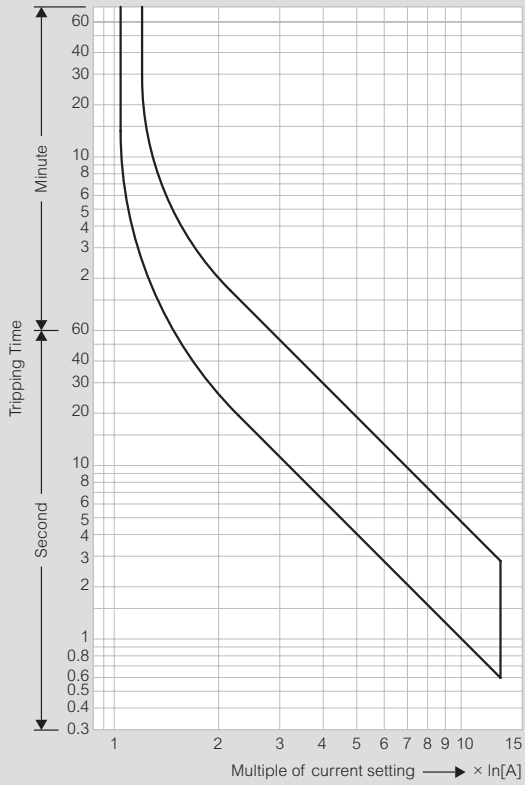

Hot starting

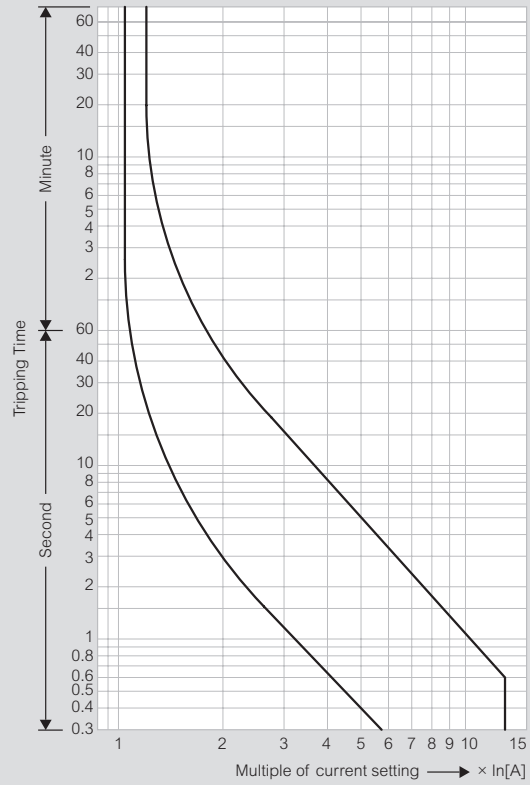

RTX³ mini - class 10A (thermal relays for CTX3 mini contactors)

Cold starting

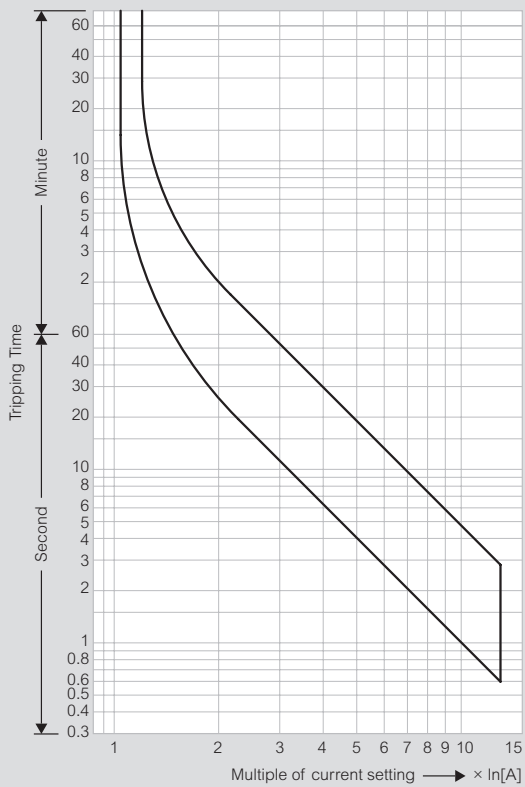

Hot starting

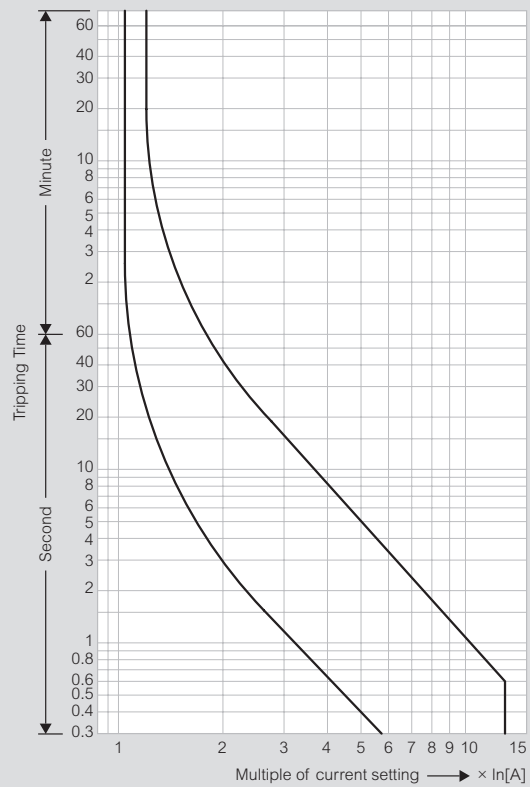

CTX³ accessories

dimensions and wiring diagrams

Auxiliary contacts for CTX³

Front mounting

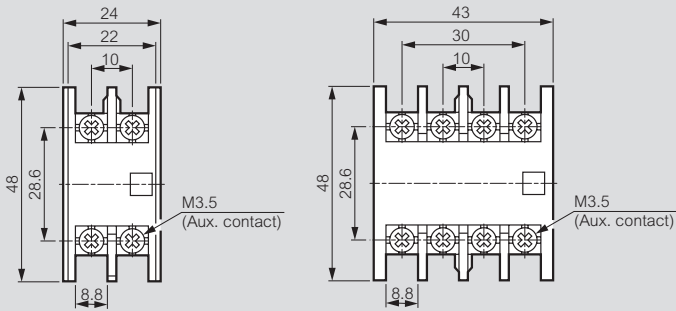

Side mounting

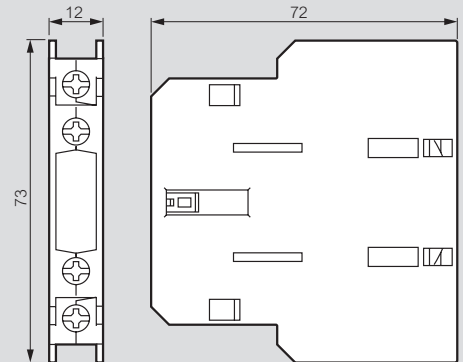

CTX³ time-delay blocks

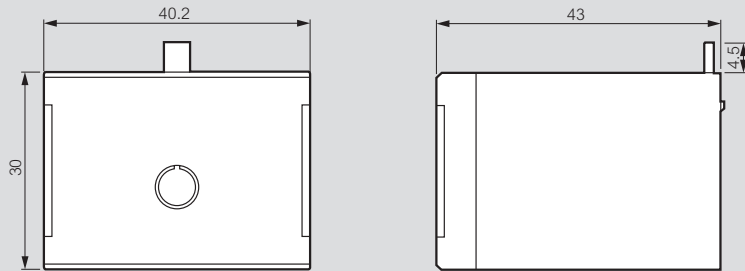

ON delay - Cat.Nos 4 168 70/71

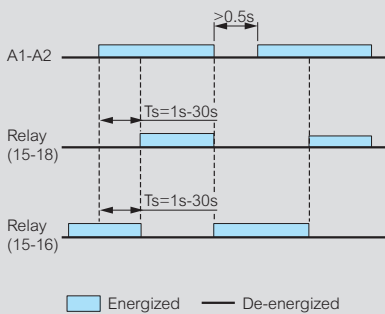

Circuit diagram

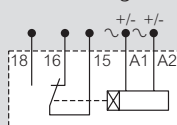

OFF delay - Cat.Nos 4 168 72/73

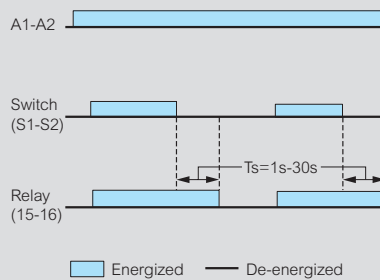

Circuit diagram

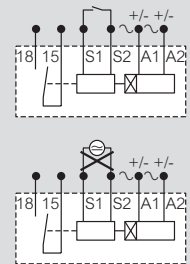

Possible combinations of auxiliary blocks per contactor

Auxiliary contact block	Size	Maximum number of blocks		
		Side mounting (1contact)	Front mounting (2 contacts)	Front mounting (4 contacts)
3-pole CTX ³	9 - 22 A	1	0	1
		1	1	0
		2	0	0
	32 - 150 A	4	0	0
		2	1	0
		2	0	1
185 - 800 A	4	0	0	
	4	0	0	
	4	0	0	
4-pole CTX ³	40 - 135 A	4	0	0
		2	1	0
	165 - 900 A	2	0	1
		4	0	0

Boxes for motor starters

Without pushbuttons - Cat.No 4 168 90

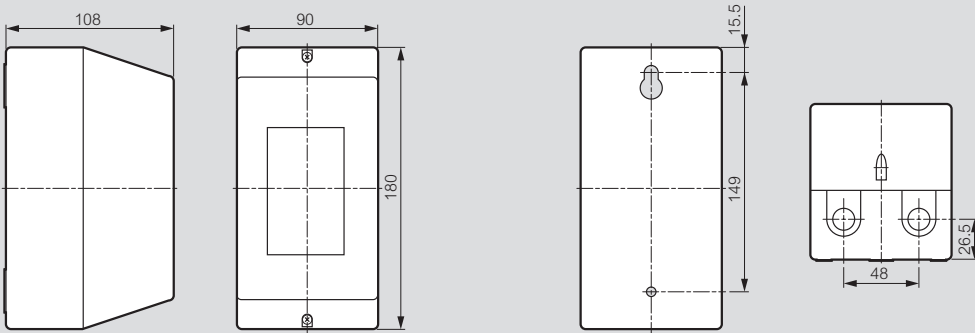

With pushbuttons - Cat.No 4 168 91

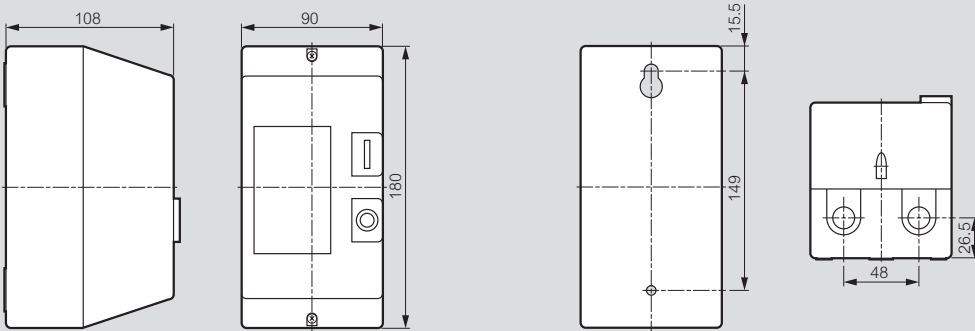

Wiring diagram - Cat.No 4 168 90

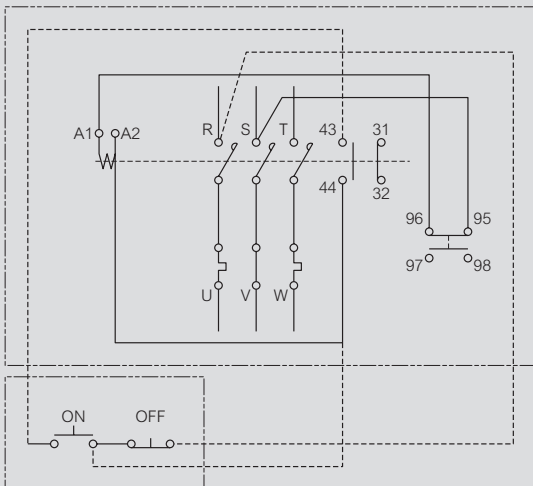

Wiring diagram - Cat.No 4 168 91

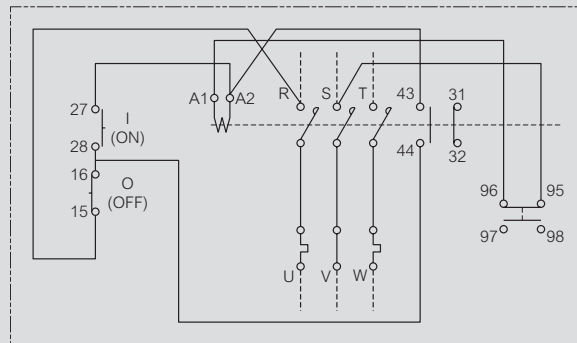

Catalogue number index

Cat.Nos	Page N°	Pack	Cat.Nos	Page N°	Pack	Cat.Nos	Page N°	Pack	Cat.Nos	Page N°	Pack	Cat.Nos	Page N°	Pack	Cat.Nos	Page N°	Pack	
4 160 80			4 161 40	32	1	4 162	03	33	1	4 162 81	33	1	4 166 40			4 167 07	34	1
4 160 80	32	1	41	-	1	04	-	1	86	-	1	4 166 40	34	1	4 167 08	-	1	
81	-	1	42	-	1	06	-	1	89	-	1	41	-	1	4 167 09	-	1	
82	-	1	43	-	1	08	-	1	90	-	1	4 166 42	34	1	4 167 10	-	1	
83	-	1	44	-	1	09	-	1	91	-	1	43	-	1	4 167 23	34	1	
84	-	1	46	-	1	10	-	1	96	-	1	44	-	1	24	-	1	
86	-	1	48	-	1	11	-	1	99	-	1	45	-	1	25	-	1	
88	-	1	49	-	1	12	-	1	4 163 00			46	-	1	26	-	1	
89	-	1	50	-	1	13	-	1	4 163 06	33	1	47	-	1	27	-	1	
90	-	1	51	-	1	14	-	1	09	-	1	48	-	1	28	-	1	
91	-	1	52	-	1	16	-	1	16	-	1	49	-	1	29	-	1	
92	-	1	53	-	1	18	-	1	19	-	1	50	-	1	30	-	1	
93	-	1	54	-	1	19	-	1	26	-	1	51	-	1	31	-	1	
94	-	1	56	-	1	20	-	1	29	-	1	52	-	1	43	-	1	
96	-	1	58	-	1	21	-	1	36	-	1	53	-	1	44	-	1	
98	-	1	59	-	1	22	-	1	39	-	1	54	-	1	45	-	1	
99	-	1	60	-	1	23	-	1	46	-	1	55	-	1	46	-	1	
4 161 00			61	-	1	24	-	1	49	-	1	56	-	1	47	-	1	
4 161 00	32	1	62	-	1	26	-	1	56	-	1	57	-	1	48	-	1	
01	-	1	63	-	1	28	-	1	59	-	1	60	-	1	49	-	1	
02	-	1	64	-	1	29	-	1	4 164 00			61	-	1	50	-	1	
03	-	1	66	-	1	30	-	1	4 164 26	35	1	62	-	1	60	-	1	
04	-	1	68	-	1	31	-	1	36	-	1	63	-	1	61	-	1	
06	-	1	69	-	1	32	-	1	46	-	1	64	-	1	62	-	1	
08	-	1	70	-	1	33	-	1	56	-	1	65	-	1	63	-	1	
09	-	1	71	-	1	34	-	1	66	-	1	66	-	1	64	-	1	
10	-	1	72	-	1	36	-	1	76	-	1	67	-	1	65	-	1	
11	-	1	73	-	1	38	-	1	86	-	1	68	-	1	70	-	1	
12	-	1	74	-	1	39	-	1	96	-	1	69	-	1	71	-	1	
13	-	1	76	-	1	40	-	1	4 165 00			70	-	1	72	-	1	
14	-	1	78	-	1	41	-	1	4 165 06	35	1	71	-	1	73	-	1	
16	-	1	79	-	1	42	-	1	16	-	1	72	-	1	80	35	1	
18	-	1	80	33	1	43	-	1	26	-	1	73	-	1	81	-	1	
19	-	1	81	-	1	46	-	1	46	-	3	74	-	1	82	-	1	
20	-	1	82	-	1	49	-	1	56	-	4	75	-	1	83	-	1	
21	-	1	83	-	1	50	-	1	66	-	1	76	-	1	84	-	1	
22	-	1	84	-	1	51	-	1	76	-	3	77	-	1	86	-	1	
23	-	1	86	-	1	52	-	1	86	-	3	78	-	1	87	-	1	
24	-	1	88	-	1	53	-	1	91	34	1	79	-	1	88	-	1	
26	-	1	89	33	1	56	-	1	92	-	1	80	-	1	89	-	1	
28	-	1	90	33	1	59	-	1	93	-	1	81	-	1	90	-	1	
29	-	1	91	33	1	60	-	1	94	-	1	82	-	1	91	-	1	
30	-	1	92	33	1	61	-	1	95	-	1	83	-	1	92	-	1	
31	-	1	93	33	1	62	-	1	96	-	1	84	-	1	93	-	1	
32	-	1	94	33	1	63	-	1	97	-	1	85	-	1	94	-	1	
33	-	1	96	33	1	66	-	1	98	-	1	86	-	1	95	-	1	
34	-	1	98	33	1	69	-	1	4 167 00			87	-	1	4 168 00			
36	-	1	99	33	1	70	-	1	4 167 03	34	1	88	-	1	4 168 00	37	1	
38	-	1	4 162 00			71	-	1	4 167 04	-	1	89	-	1	01	-	1	
39	-	1	4 162 00	33	1	72	-	1	4 167 05	-	1	90	-	1				
			01	-	1	73	-	1	4 167 06	-	1							
			02	-	1	76	-	1										
						79	-	1										
						80	-	1										



FOLLOW
US ON

@ website: www.legrand.eg

f legrand

@ legrandegypt



EMB Electrical Industries S.A.E.

Headquarter office

Pyramids Heights Office Park
KM 22 Cairo - Alex. desert road
Building 1B, 12556
Tel.: +202 3536 0000
Fax: +202 3536 0001
www.legrand.eg