

FIBER OPTIC SYSTEM



TAKING HIGH DENSITY TO THE NEXT LEVEL
WITH NEW INTEGRATED SOLUTIONS

CATALOGUE
PAGES
→ INSIDE



A RELIABLE PARTNER FOR YOUR DIGITAL INFRASTRUCTURES

The Legrand group is a world leader in communication networks for data transmission. Its investment in the development and design of structured cabling solutions enables the Group to expand its offer so as to remain at the highest level of performance for data centers and smart building installations.



THE SCOPE OF ITS OFFERING
AND ITS LEADING POSITIONS
MAKE THE LEGRAND GROUP
**A WORLDWIDE BENCHMARK
AND A RELIABLE PARTNER
FOR ALL YOUR PROJECTS**





3 DIMENSIONS OF EXCELLENCE

To provide you with ever-more cutting-edge and efficient systems, the Legrand group strengthens its LCS³ fiber optic offer with new High Density solutions! These solutions meet the three dimensions of excellence, inherent to the LCS³ solutions, that perfectly address the key challenges for digital networks: performance, scalability and efficiency!



PERFORMANCE

- 40 Gbps, 100 Gbps and 400 Gbps Ethernet applications
- Higher bandwidth & lower latency
- MTP/MPO high performance and density



SCALABILITY

- High density solutions optimizing space
- Greater connectivity capacity making way for future evolutions without modification of the installation
- Agile and flexible solutions enabling easy changes



EFFICIENCY

- Easy installation and easy maintenance reducing time, cost and risks when changing or adding solutions
- Possibility to mix fiber & copper to meet all needs with one installation
- Product Environmental Profiles for the new slim cassettes and panels



CREATING FULL HD FIBER

Legrand boosts its high density offer for building networks and data center applications within LCS³ fiber systems. From 1U to 4U, they support the fiber and equipment port density required for all networks with high and even ultra high density (UHD version see p.28)

Base 12, MTP(F) to MTP(F),
Type B, OM4 trunk in Fiber
raceway system*

4U HD panel

Cat.No 0 321 77
Can hold 32 slim cassettes
(into 16 supports) and/or MTP,
splice fiber, copper cassettes

Slim multimode OM4 cassettes

Cat.No 0 321 69
12 fibers, MTP(M)-LC duplex,
universal polarity
To be connected with OM4
duplex LC patch cord, A-B*

Support for slim cassettes

Cat.No 0 321 38
Can take up to 2 slim cassettes
12 fibers, MTP(M)-LC duplex,
universal polarity

NEAR END

SYSTEMS

1U HD panel

Cat.No 0 321 75
Can hold 8 slim cassettes
(into 4 supports) and/or MTP,
splice fiber, copper cassettes

Slim multimode OM4 cassettes

Cat.No 0 321 69
12 fibers, MTP(M)-LC duplex,
universal polarity
To be connected with OM4 duplex
LC patch cord, A-B*

Support for slim cassettes

Cat.No 0 321 38
Can take up to 2 slim cassettes
12 fibers, MTP(M)-LC duplex,
universal polarity

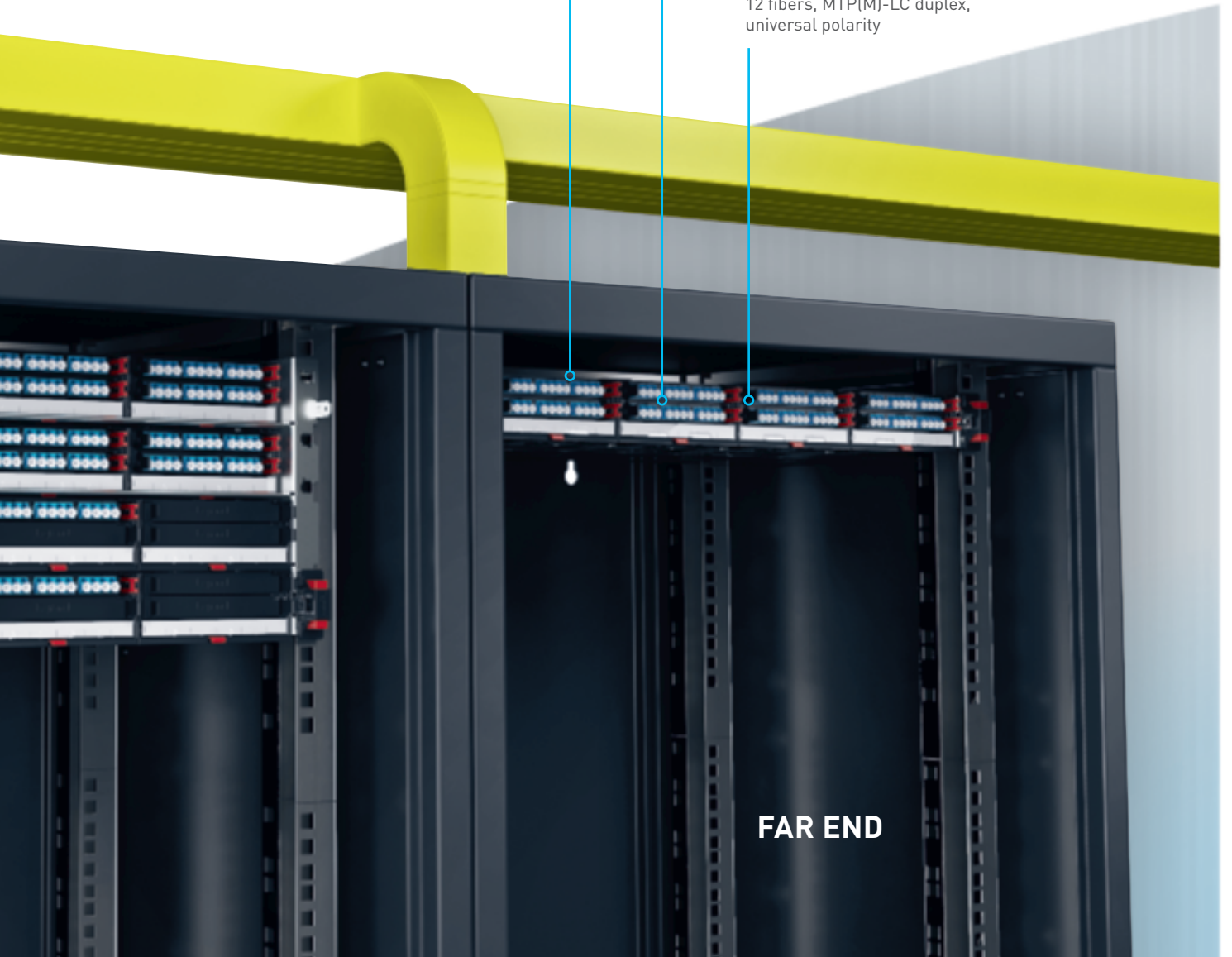

FAR END

* Configured offer possible on request

HIGH DENSITY MODULAR PANELS

From 1U to 4U

Optimize space and connectivity with our three new HD modular panels! These quick-fixing solutions (automatic mounting and automatic grounding on 19" uprights) offer you optimum capacities per U: 96 in LC version, 48 in SC version and 24 in ST version! Keeping link connections accessible and manageable, they offer slim and mix-media cassettes.

4U HIGH DENSITY PANEL
Can hold up to 32 slim cassettes (into 16 supports)

Rear management accessories to suit all configurations: fan out, cable glands, copper

Possibility to mix fiber and copper cassettes in one panel

Each panel can be equipped with both standard and slim High Density cassettes

Quick fixing solutions on all the versions from 1U to 4U

Cord management system (except for the 1U panel, to be equipped with Cat.No 0 321 78) with front, side and bottom protection of the patchcords, preventing any risk of damage

Labeling system for easy identification

Equipped with the new-generation Quick-fix system for automatic (screwless) mounting on racks or cabinet uprights

Integrated front door for protection against intrusive patching and laser

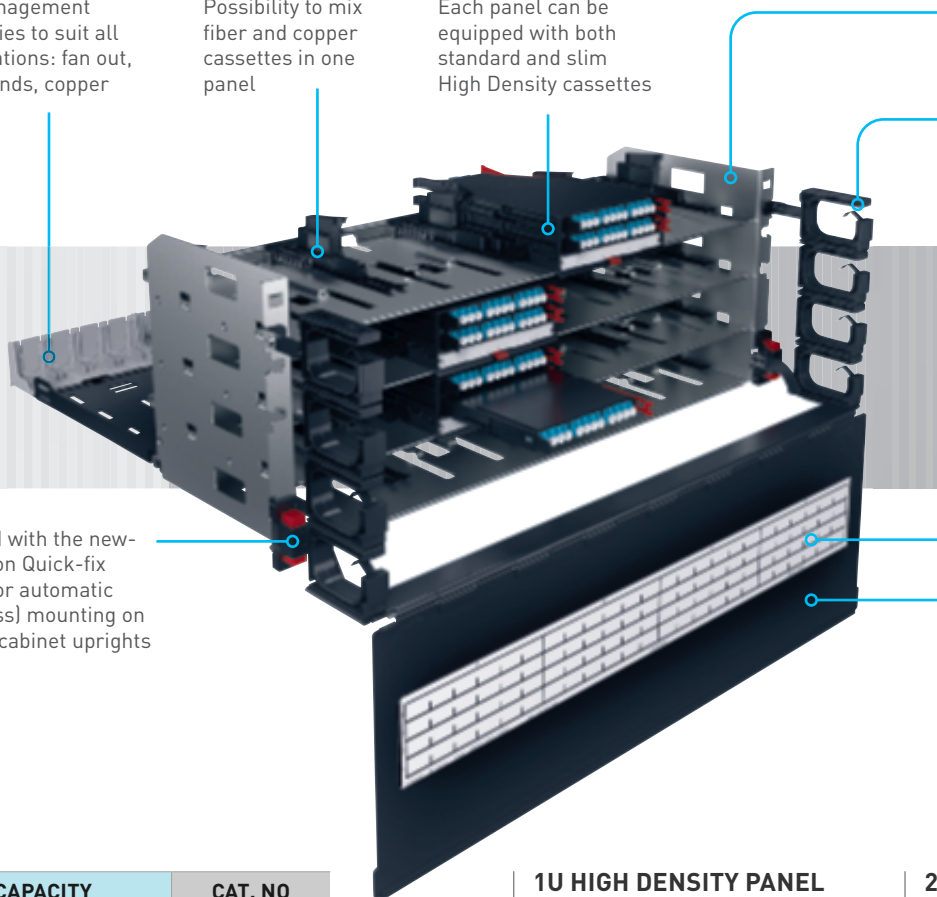

CAPACITY	CAT. NO
1U High Density panel	0 321 75
2U High Density panel	0 321 76
4U High Density panel	0 321 77

1U HIGH DENSITY PANEL
Can hold up to 8 slim cassettes (into 4 supports)

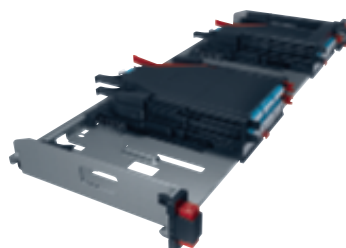

2U HIGH DENSITY PANEL
Can hold up to 16 slim cassettes (into 8 supports)



Flexibility of installation

Our new high density modular panels offer complete freedom of installation: opt for a top-of-rack or an in-rack installation depending on your site constraints and your infrastructure's configuration!

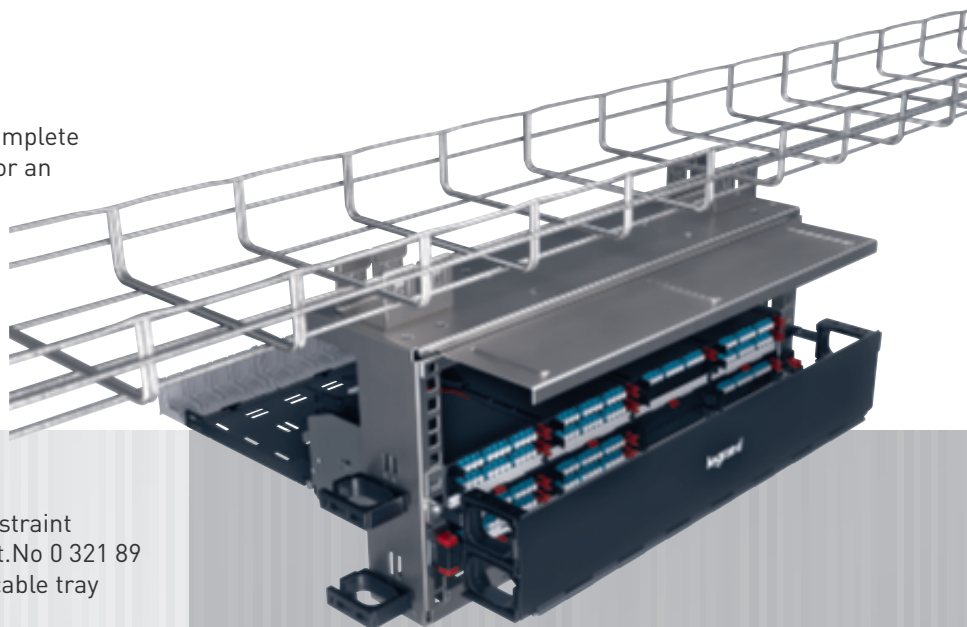

TOP-OF-RACK INSTALLATION

Optimize space and meet any technical constraint thanks to the overhead solution! The kit Cat.No 0 321 89 enables you to fix the modular panels to a cable tray (Cablofil) above of the enclosure.

IN-RACK INSTALLATION

Easily mount the modular panels directly into the LCS³ enclosures and equip them with any type of cassettes in order to meet your specific needs!

1U, 2U and 4U panels equipped with:

- slim cassettes
- splice cassettes with 8 MTP adaptors
- copper cassettes
- blanking cassettes



UNIVERSAL FIXING

Thanks to the Zero-U kit, you can mount cassettes on 19" uprights, raised access floors, wire and sheet metal cable trays, structural uprights of the enclosure, etc. (see p.9)

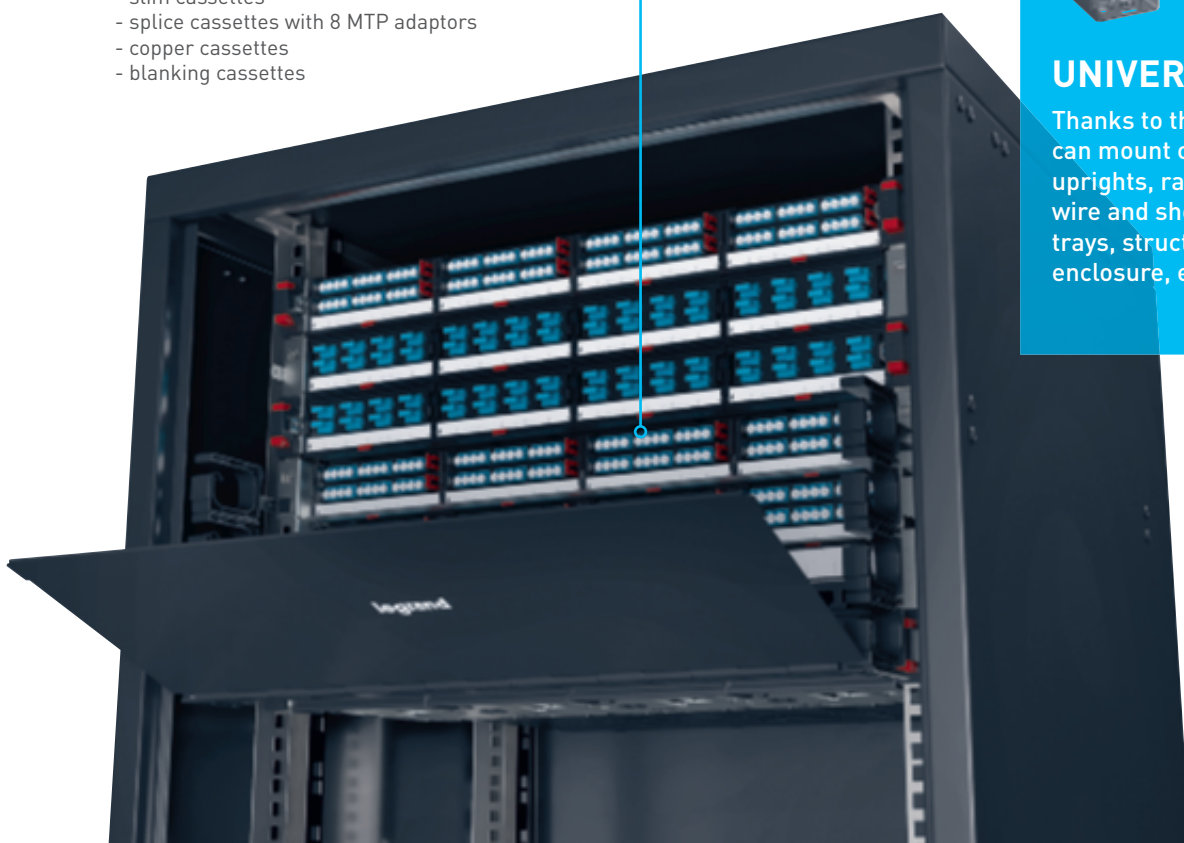

CASSETTES

Slim solutions for greater connectivity

Optimize space and increase the connectivity capacity of your infrastructure with the new slim cassettes! Easy to install and to maintain from rear and front, they prove to be agile and flexible under all circumstances.

- Mounting either on High Density modular panels or in Zero-U kit
- Single-mode and multimode MTP solutions that can be mixed on the same support
- Sliding cassettes individually removable from front and rear: accessible and easily manageable
- Equipped with extraction button for easy maintenance: reduced time, cost and risk of MAC
- High-performance with low insertion loss
- Universal polarity offering flexibility in case of changes

TYPE	CAT. NO
12 LC OM4 multimode	0 321 69
12 LC OM3 multimode	0 321 68
12 LC OS2 single-mode	0 321 70
Blanking module	0 321 39



OM4 multimode slim cassette - Cat.No 0 321 69



OS2 single-mode slim cassette - Cat.No 0 321 70

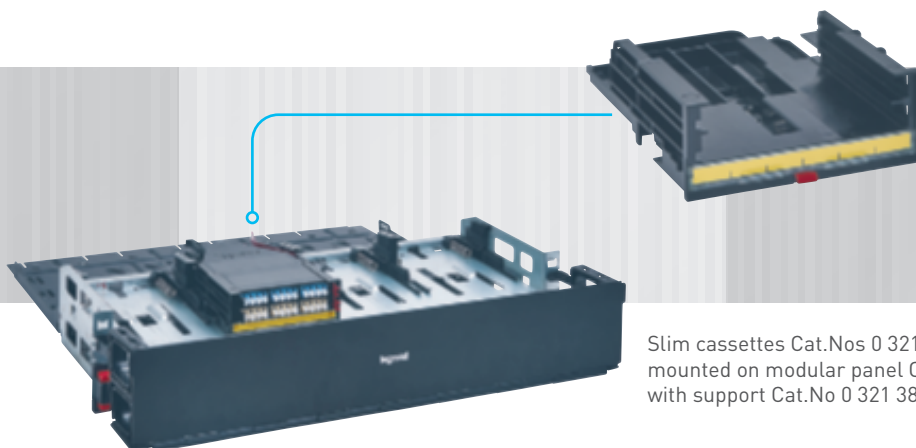

Slim cassettes are to be mounted on HD modular panels with support Cat.No 0 321 38. The support can take up to 2 slim cassettes.

Slim cassettes Cat.Nos 0 321 69/70 mounted on modular panel Cat.No 0 321 76 with support Cat.No 0 321 38

PATCHING KITS

Zero-U kit for universal fixing

The Zero-U kit Cat.No 0 321 03 enables you to mount cassettes on 19" uprights, raised access floors, wire and sheet metal cable trays, structural uprights of the enclosure, etc.

The kit can take up to 2 slim High Density cassettes Cat.Nos 0 321 68/69/70 or 1 universal High Density cassette Cat.No 0 321 59 or 0 321 60.

- Efficient solution to optimize space without the need to add an enclosure
- Compatible with 1U, 2U and 4U High Density modular panels
- Easy mounting on cable trays (such as Cablofil) thanks to quick-fixing solutions



1U to 4U kit for overhead fixing

No space available in your LCS³ enclosure? The innovative kit Cat.No 0 321 89 enables you to fix the High Density modular panels on wire cable trays, above the enclosure.

- Perfect toolless fitting on cable trays. Can also be installed on roofs of racks
- Maintains duplex multimode fiber architecture
- Scalable (move, add, change) and efficient (space optimization) system
- Easy installation and maintenance
- Can be equipped with fiber optic and copper solutions
- Compatible with automatically removable cassettes
- Accommodates the same solutions as 19" patch panels

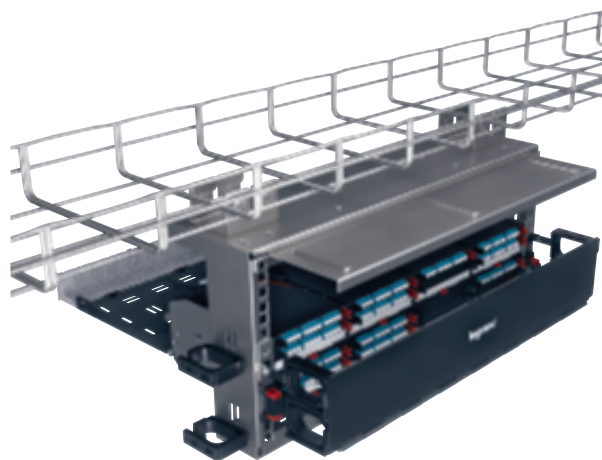

READY FOR FUTURE APPLICATIONS!

With our new on-demand OM5 offer, we meet all your requirements in terms of connectivity! The infrastructure can easily evolve from 25 G or 50 G to 100 G and to 400 G thanks to parallel and multiplexing applications.

OM5 multimode MTP adaptor



OM5 12 LC multimode block

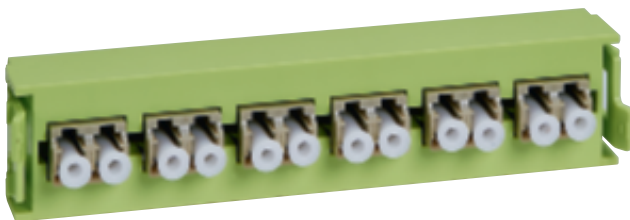

Performance and wavelength

OM3 and OM4 fibers are optimized according to the wavelength traditionally used: 850nm. To accept the 4 signals used in multimode WDM, OM5 has been redesigned to accept wavelengths from 850nm to 950nm. The diagrams below provide a graphical representation.

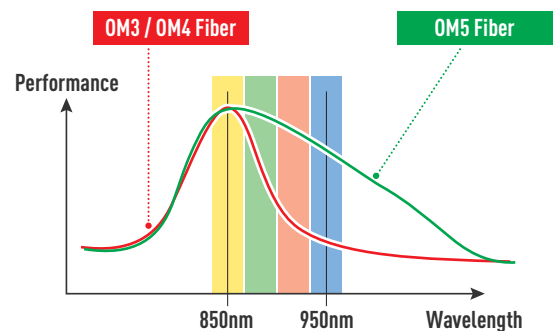
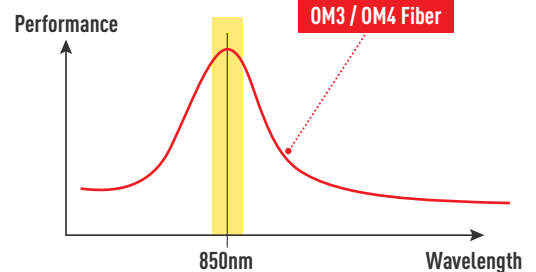



Application upgrades

By considering all the current applications, either standardized or recognized through multi-source agreements, as well as draft applications to be standardized soon, we can establish the following evolutions of the applications optimized per type of multimode cabling:

- 1** Duplex channel for single wavelength (typically duplex LC connector with OM3 or OM4 fiber):
10GBASE-SR → 25GBASE-SR → 50GBASE-SR*
- 2** Duplex channel for multiple wavelength (typically duplex LC connector with OM5 fiber):
10GBASE-SR → 25GBASE-SR → 40G-SWDM4 → 50GBASE-SR → 100G-BiDi or 100G-SWDM4*
- 3** Multiple fiber solution for parallel optics (typically MPO connector with OM3 or OM4 fiber):
40GBASE-SR4 → 100GBASE-SR4 → 200GBASE-SR4*
- 4** Multiple fiber solution for parallel optics and multiple wavelengths (typically MPO connector with OM5 fiber):
40GBASE-SR4 → 100GBASE-SR4 → 200GBASE-SR4 → 400GBASE-SR4.2 or 400G-BD4.2*

The best of both worlds

To ensure the maximum lifespan of the fiber cabling, it is important to select the right fiber type and design. Today, a duplex OM4 channel can only expect to reach 50Gbps to the maximum distance. To reach 200Gbps, two options are available: duplex channel for multiple wavelength or multiple fiber solution for parallel optics.

But to reach 400Gbps, the best solution is the combination of all technologies together.

To allow the multimode fiber infrastructure to reach 400Gbps, the best option today is to provide for the full range of technologies. This currently means using OM5 cables with MPO connectors.

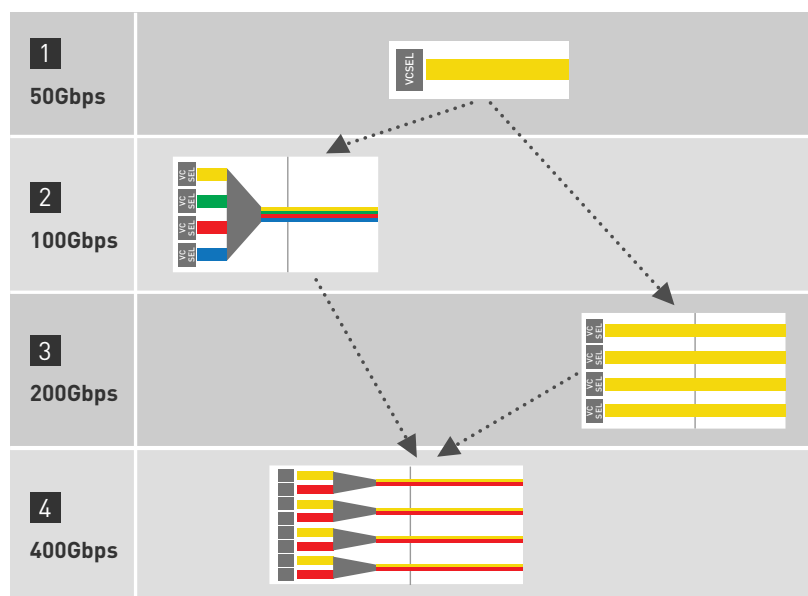

*See TR ISO/IEC 11801-9908: "Guidance for the support of higher speed applications over optical fiber channels" for further information. Note that some multiple wavelength applications can function on OM3 and OM4, but to limited distance.

CONTACT US FOR MORE INFORMATION ABOUT THE CUSTOMIZED OFFER

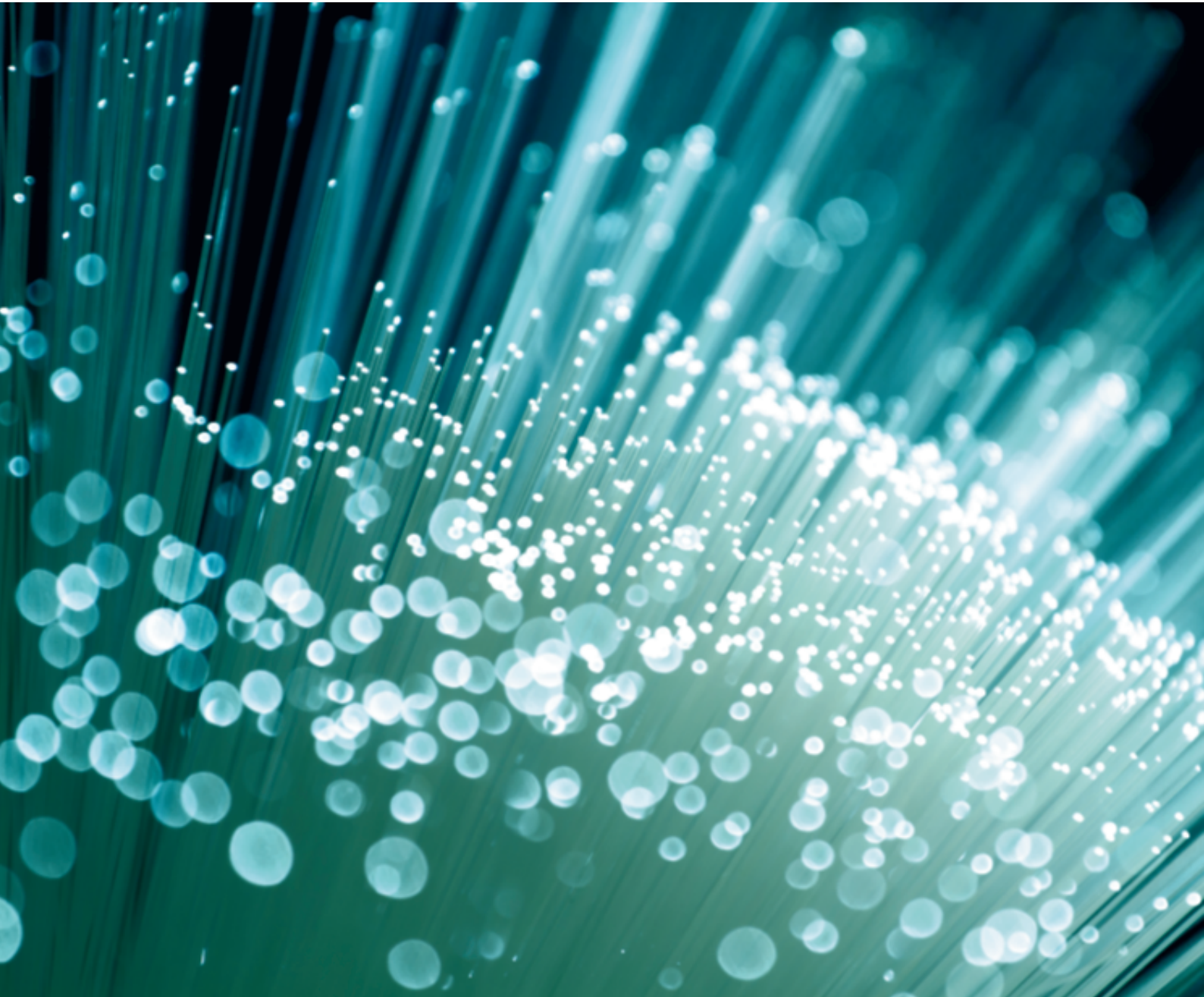

CONTENTS

Selection charts	14
Cables	24
Preterminated links	25
High Density preterminated links	25
19" fiber optic drawers	26
19" High Density fiber optic panels	27
19" Ultra High Density fiber optic drawers	28
Pigtails, glue-on connectors and fan-out units	29
Case and quick-connect connectors	29
Patch cords and feedthrough sockets	30
Technical characteristics	31



Legrand cabling system, LCS³ fiber optic selection chart

19" standard solutions

CONFIGURE YOUR LCS³ FIBER OPTIC SYSTEM

Example:

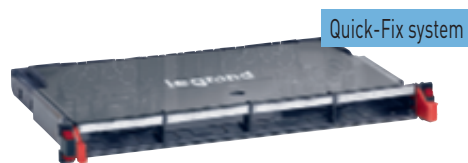

Modular drawer

+

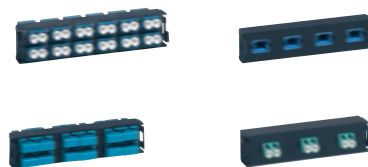

Blocks

+

DRAWERS TO BE EQUIPPED (p.26)

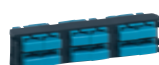
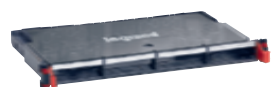

FIBER OPTIC DRAWERS				FIBER OPTIC BLOCKS									
Size	Type	Cat.No	Max. number of blocks	Number of fibers	SC duplex		SC duplex HD		SC APC duplex	LC duplex			
					Multimode	Single-mode	Multimode	Single-mode	Single-mode	Multimode	Single-mode		
FLAT DRAWERS - QUICK-FIX SYSTEM													
19" modular	To be equipped with fiber optic blocks	0 321 00	4	6	0 321 20	0 321 10	-	-	0 321 12	0 321 23	0 321 13		
				12	-	-	0 321 21	0 321 11	-	0 321 24		0 321 14	
				24	-	-	-	-	-	-	0 321 37 (aqua)		-
	ANGLED DRAWERS - QUICK-FIX SYSTEM												
	19" modular	To be equipped with fiber optic blocks	0 321 01	4	6	0 321 20	0 321 10	-	-	0 321 12	0 321 23	0 321 13	
					12	-	-	0 321 21	0 321 11	-	0 321 24		0 321 14
24					-	-	-	-	-	-	0 321 37 (aqua)	-	

EQUIPPED DRAWERS (P.26)

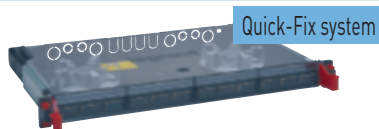

Size	Type	Capacity (fibers)	SC duplex		SC APC duplex
			Multimode	Single-mode	Single-mode
19" modular	SLIDING				
	Quick-Fix system	24	0 321 02	0 321 06	-
48		-	-	-	
19"	SLIDING				
	Screw fixing	24	0 321 61	0 321 64	0 321 66
		48	-	-	-
	ROTATING				
	Screw fixing	36	0 321 72	0 321 74	-
		72	-	-	-

1 : MTP is a registered trademark of US Conec Ltd

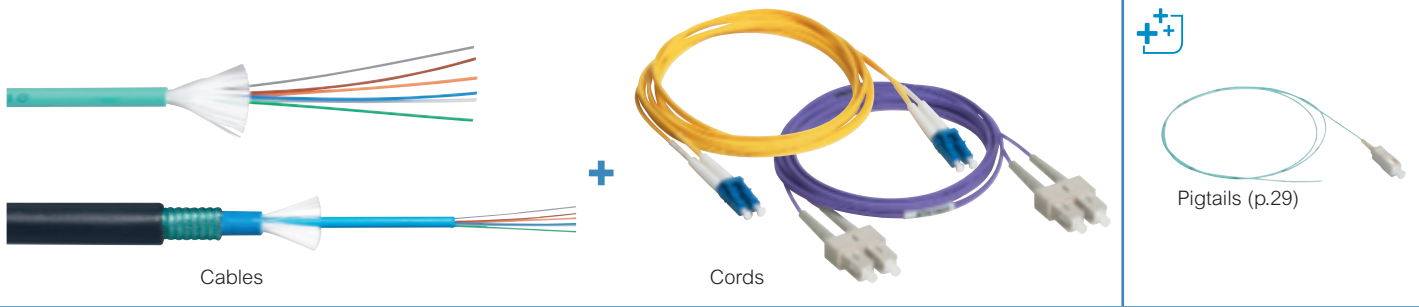

ACCESSORIES

LC duplex HD		LC APC duplex	ST		4 MTP ⁽¹⁾ feedthrough adaptor		Blanking plate	Copper block for 5 RJ45	Cassette for pigtail	Coiling kit	Accessory for fan-out
Multimode	Single-mode	Single-mode	Multimode	Single-mode	Multimode	Single-mode					
-	-	-	0 321 27	0 321 17	0 321 34	0 321 33	0 321 29	0 321 32	0 321 30	0 321 31	0 321 28
-	-	0 321 16	-	-							
0 321 25	0 321 15	-	-	-							
-	-	-	0 321 27	0 321 17	0 321 34	0 321 33	0 321 29	-	0 321 30	0 321 31	0 321 28
-	-	0 321 16	-	-							
0 321 25	0 321 15	-	-	-							

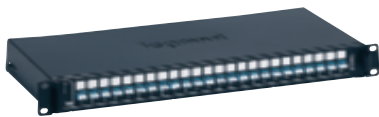

LC duplex		LC APC duplex	ST
Multimode	Single-mode	Single-mode	Multimode
-	-	-	-
0 321 04	-	-	-
-	-	-	0 321 63
0 321 62	0 321 65	0 321 67	-
-	-	-	-
0 321 71	0 321 73	-	-

Legrand cabling system, LCS³ fiber optic selection chart

19" High Density solutions

CONFIGURE YOUR LCS³ HIGH DENSITY FIBER OPTIC SYSTEM

Example:



Modular panel

+

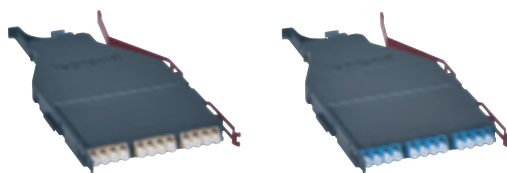

Cassettes

+

HIGH DENSITY PANELS TO BE EQUIPPED (p.27)

HIGH DENSITY PANELS																		
Size	Type	Cat.No			Capacity for 1U	Cat.No	Number of fibers	SC		SC HD		SC APC	LC					
		1 U	2 U	4 U				Multimode	Single-mode	Multimode	Single-mode	Single-mode	Multimode					
High Density 19" modular	To be equipped with cassettes to be equipped with fiber optic blocks	0 321 75	0 321 76	0 321 77	4	0 321 41	CASSETTES TO BE EQUIPPED						FIBER OPTIC BLOCKS					
							6	0 321 20 (duplex)	0 321 10 (duplex)	-	-	0 321 12	0 321 23 (duplex)	0 321 36 (duplex-aqua)				
							12	-	-	0 321 21 (duplex)	0 321 11 (duplex)	-	0 321 24 (duplex)	0 321 37 (duplex-aqua)				
	24						-	-	-	-	-	-	-					
	To be equipped with pre-equipped cassettes (supplied with set of 6 or 12 OM3 pigtails)						PRE-EQUIPPED CASSETTES						PRETERMINATED (A/C POLARITY)					
							12	-	-	0 321 43 (OM4)	0 321 45 (OS2)	-	0 321 48 (OM4)					
							24	-	-	0 321 59 (OM4)	0 321 60 (OS2)	-	-					
							WITH FIBER OPTIC BLOCKS + PIGTAILS						6	-	-	0 321 80 (duplex-OM3);	0 321 84 (duplex-OM3)	-
	12						-	-	0 321 82 (duplex-OM3);	0 321 86 (duplex-OM3)	-	-						
	To be equipped with slim cassettes						SUPPORT FOR SLIM CASSETTES						PRETERMINATED - SLIM CASSETTES (UNIVERSAL POLARITY)					
							4	0 321 38	12	-	-	-	-	-				
	Zero-U kit						To be equipped with slim cassettes	SUPPORT FOR SLIM CASSETTES						PRETERMINATED - SLIM CASSETTES (UNIVERSAL POLARITY)				
1		0 321 38	12	-	-	-		-	-									
To be equipped with pre-equipped cassettes (supplied with set of 6 or 12 OM3 pigtails)		PRE-EQUIPPED CASSETTES						PRETERMINATED (A/C POLARITY)										
		12	-	-	-	-	-	-										
		24	-	-	-	-	-	-										
		WITH FIBER OPTIC BLOCKS + PIGTAILS						6	-	-	0 321 80 (duplex-OM3);	0 321 84 (duplex-OM3)	-	-				
12	-	-	0 321 82 (duplex-OM3);	0 321 86 (duplex-OM3)	-	-												

1 : MTP is a registered trademark of US Conec Ltd



Links

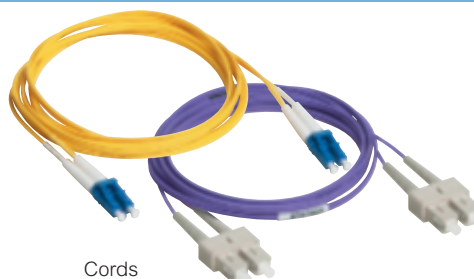

Cords



Pigtails (p.29)

										ACCESSORIES		
		LC HD		LC APC	ST		8 MTP ⁽¹⁾ feedthrough adaptor		Blanking cassette	RJ45 copper cassette to be equipped	Cable management accessory	Front management HD modular panel
Single-mode	Multimode	Single-mode	Single-mode	Multimode	Single-mode	Multimode	Single-mode					
0 321 13	-	-	-	-	0 321 27	0 321 17	-	-	0 337 57	0 337 55 (to be equipped with copper connectors)	0 321 46 (for 1 U panel only, supplied for 2 U and 4 U panels)	0 321 78 (for 1 U panel only, supplied for 2 U and 4 U panels)
0 321 14 (duplex)	-	-	0 321 16	-	-	-	0 321 18	0 321 19	0 337 57	0 337 55 (to be equipped with copper connectors)	0 321 46 (for 1 U panel only, supplied for 2 U and 4 U panels)	0 321 78 (for 1 U panel only, supplied for 2 U and 4 U panels)
-	0 321 25 (duplex)	0 321 15 (duplex)	-	-	-	-	-	-	-	-	-	-
0 321 49 (OS2)	-	-	-	-	-	-	-	-	0 337 57	0 337 55 (to be equipped with copper connectors)	0 321 46 (for 1 U panel only, supplied for 2 U and 4 U panels)	0 321 78 (for 1 U panel only, supplied for 2 U and 4 U panels)
-	0 321 42 (OM4)	0 321 44 (OS2)	-	-	-	-	-	-	0 337 57	0 337 55 (to be equipped with copper connectors)	0 321 46 (for 1 U panel only, supplied for 2 U and 4 U panels)	0 321 78 (for 1 U panel only, supplied for 2 U and 4 U panels)
-	0 321 81 (duplex-OM3)	0 321 85 (duplex-OM3)	-	-	-	-	-	-	-	-	-	-
-	0 321 83 (duplex-OM3)	0 321 87 (duplex-OM3)	-	-	-	-	-	-	-	-	-	-
-	0 321 69 (OM4) 0 321 68 (OM3)	0 321 70 (OS2)	-	-	-	-	-	-	0 321 39	0 337 55 (to be equipped with copper connectors)	0 321 46 (for 1 U panel only, supplied for 2 U and 4 U panels)	0 321 78 (for 1 U panel only, supplied for 2 U and 4 U panels)
-	0 321 69 (OM4) 0 321 68 (OM3)	0 321 70 (OS2)	-	-	-	-	-	-	0 321 39	-	-	-
-	0 321 48 (OM4)	0 321 49 (OS2)	-	-	-	-	-	-	-	-	-	-
-	0 321 42 (OM4)	0 321 44 (OS2)	-	-	-	-	-	-	-	0 337 55 (to be equipped with copper connectors)	-	-
-	0 321 81 (duplex-OM3)	0 321 85 (duplex-OM3)	-	-	-	-	-	-	-	-	-	-
-	0 321 83 (duplex-OM3)	0 321 87 (duplex-OM3)	-	-	-	-	-	-	-	-	-	-

Legrand cabling system, LCS³ fiber optic selection chart

19" Ultra High Density solutions

CONFIGURE YOUR LCS³ ULTRA HIGH DENSITY FIBER OPTIC SYSTEM

Example:

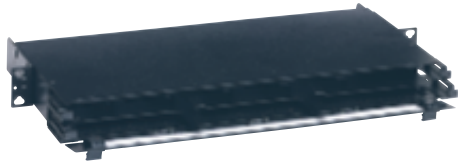

Modular drawer



Cassettes



ULTRA HIGH DENSITY DRAWERS TO BE EQUIPPED (P.28)

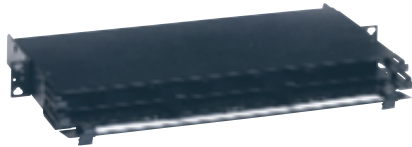

Ultra High Density drawers

Ultra High Density cassettes

Size	Type	Height	Number of cassettes per U	Cat.No	Number of fibers (links)	Multimode OM4		
Ultra High Density 19" modular	Cord management from the front and the back							
	To be equipped with 8-fiber cassettes	1 U	18	0 321 90	8	0 321 93		
		2 U		0 321 91				
		4 U		0 321 92				
	To be equipped with 12-fiber cassettes	1 U	12	0 321 50	12	0 321 54		
		2 U		0 321 52				
		4 U		0 321 53				
	Cord management from the front							
	To be equipped with 12-fiber cassettes	1 U	12	0 321 51	12	0 321 54		

1 : MTP is a registered trademark of US Conec Ltd



Links

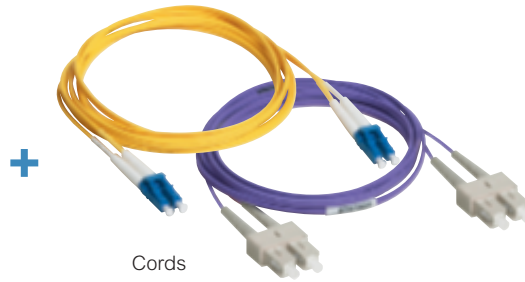

Cords



Adaptors

	Single-mode OS2	Adaptors				
		LC		4 MPO (MTP ⁽¹⁾ compatible)		
		Multimode	Single-mode	APC single-mode	Multimode	Single-mode
	0 321 94	0 321 97	0 321 98	0 321 99	0 321 95	0 321 96
	0 321 55	0 321 58	-	-	0 321 56	0 321 57
	0 321 55	0 321 58	-	-	0 321 56	0 321 57

Legrand cabling system, LCS³ fiber optic selection chart

pigtails, cables and patch cords

PIGTAILS (p.29)

Length (m)	OS2 - 9/125 μm					OM2 - 50/125 μm			OM3 - 50/125 μm		
	SC - APC	LC - APC	SC - UPC	LC - UPC	ST - UPC	SC	LC	ST	SC	LC	ST
1	0 322 40	0 322 42	0 322 41	0 322 43 0 326 24 (set of 12 pigtails)	0 322 44	0 322 10	0 322 11	0 322 12	0 322 20	0 322 21 0 326 26 (set of 12 pigtails)	0 322 22
2	0 322 45	0 322 48	0 322 46	0 322 47	0 322 49	0 322 13	0 322 14	0 322 15	0 322 23	0 322 24	-

CABLES (p.24)

Drum 2000m except information	OS2 - 9/125 μm				
	Number of fibers				
	4	6	8	12	24
Tightbuffer LSZH sheath Indoor/Outdoor				0 325 50	
Loose LSZH sheath Indoor/Outdoor	0 325 02	0 325 12	0 325 03	0 325 14 (Dca) 0 325 26 (Cca)	0 325 51
Loose PE sheath corrugated steel OUTDOOR CORRUGATED STEEL	0 325 23	0 325 13	0 325 24	0 325 15	0 325 25

PATCH CORDS (p.30)

Length (m)	OS2 - 9/125 μm				OM2 - 50/125 μm				
	SC/SC duplex	SC/LC duplex	LC/LC duplex	LC/LC Uniboot duplex	ST/ST duplex	SC/SC duplex	ST/SC duplex	LC/LC duplex	
0.5	-	-	0 326 28	-	-	-	-	-	-
1	0 326 00	0 326 03	0 326 06	0 326 86	0 330 80	0 330 69	-	-	-
2	0 326 01	0 326 04	0 326 07	0 326 87	0 330 81	0 330 70	0 330 72	0 330 61	-
3	0 326 02	0 326 05	0 326 08	0 326 88	0 330 82	0 330 71	0 330 73	-	-
5	-	-	0 326 29	0 326 89	-	-	-	-	-
10	-	-	-	0 326 92	-	-	-	-	-

OM4 - 50/125 μm									
OM4 - 50/125 μm			Heat-shrinkable sleeve	50/125 and 62.5/125 μm glue-on connectors			Fan-out units		
SC	LC	ST		SC	LC	ST	6 fibers	12 fibers	
0 322 30	0 322 31 0 326 71 (set of 12 pigtails)	0 322 32	0 327 44 (pack of 50 sleeves)	0 331 47	0 331 00	0 331 27	0 330 48	0 330 49	
0 322 33	0 322 34	-							

OM3 - 50/125 μm					OM4 - 50/125 μm				
Number of fibers					Number of fibers				
4	6	8	12	24	4	6	8	12	24
	0 325 10		0 325 11	0 325 52		0 326 65 (drum 500m) 0 326 66 (drum of 1000m)		0 325 67 (drum 1000m)	0 326 68 (drum 1000m)
0 325 37		0 325 38	0 325 39	0 325 53	0 325 43		0 325 44	0 325 45 (Dca) 0 325 49 (Cca)	
		0 325 40	0 325 41	0 325 42	0 325 46		0 325 47	0 325 48	

OM3 - 50/125 μm										OM4 - 50/125 μm		
SC/LC duplex	LC/ST duplex	SC/SC duplex	SC/LC duplex	LC/LC duplex	SC/SC duplex	LC/LC duplex	LC/LC Uniboot duplex					
-	-	-	-	-	-	0 326 33	-					
0 330 75	-	0 326 09	0 326 12	0 326 15	0 326 30	0 326 34	0 326 95					
0 330 63	0 330 65	0 326 10	0 326 13	0 326 16	0 326 31	0 326 35	0 326 96					
0 330 76	-	0 326 11	0 326 14	0 326 17	0 326 32	0 326 36	0 326 97					
-	-	-	-	-	-	0 326 37	0 326 98					
-	-	-	-	-	-	-	0 326 99					

Legrand cabling system, LCS³ fiber optic selection chart

simplex preterminated links and High Density preterminated links

LCS³ SIMPLEX PRETERMINATED LINKS (p.25)



Length (m)	Tight-buffer OM3		
	6 SC - 6 SC	12 SC - 12 SC	
10	1 320 01	1 320 21	
20	1 320 02	1 320 22	
30	1 320 03	1 320 23	
40	1 320 04	1 320 24	
50	1 320 05	1 320 25	
60	1 320 06	1 320 26	
70	1 320 07	1 320 27	
80	1 320 08	1 320 28	
90	1 320 09	1 320 29	
100	1 320 10	1 320 30	
120	1 320 12	1 320 32	
140	1 320 14	1 320 34	
160	1 320 16	1 320 36	
180	1 320 18	1 320 38	
200	1 320 20	1 320 40	

LCS³ HIGH DENSITY PRETERMINATED LINKS (p.25)



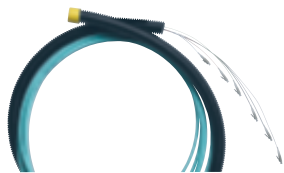

Length (m)	Fan-out - Fan-out OS2		Fan-out - Fan-out OM3	
	6 LC duplex - 6 LC duplex	12 LC duplex - 12 LC duplex	6 LC duplex - 6 LC duplex	12 LC duplex - 12 LC duplex
10	0 324 21	0 324 31	0 324 01	0 324 11
20	0 324 22	0 324 32	0 324 02	0 324 12
30	0 324 23	0 324 33	0 324 03	0 324 13
40	0 324 24	0 324 34	0 324 04	0 324 14
50	0 324 25	0 324 35	0 324 05	0 324 15

1 : MTP is a registered trademark of US Conec Ltd



	6 LC - 6 LC	12 LC - 12 LC
	1 320 41	1 320 61
	1 320 42	1 320 62
	1 320 43	1 320 63
	1 320 44	1 320 64
	1 320 45	1 320 65
	1 320 46	1 320 66
	1 320 47	1 320 67
	1 320 48	1 320 68
	1 320 49	1 320 69
	1 320 50	1 320 70
	1 320 52	1 320 72
	1 320 54	1 320 74
	1 320 56	1 320 76
	1 320 58	1 320 78
	1 320 60	1 320 80

OM5 simplex preterminated links
On request

		
MTP⁽¹⁾ OS2	MTP⁽¹⁾ OM3	
MTP⁽¹⁾ - MTP⁽¹⁾ 12 fibers	MTP⁽¹⁾ - MTP⁽¹⁾ 12 fibers	
	0 324 51	0 324 41
	0 324 52	0 324 42
	0 324 53	0 324 43
	0 324 54	0 324 44
	0 324 55	0 324 45

OM5 High Density preterminated links
On request

Legrand cabling system, LCS³ fiber optic

cables

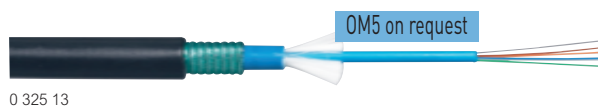

Selection chart p.20-21

Colour code: FOTAG
 Compliant with EN 50173-2 and ISO IEC 11801 standards
 Packed on a 2000 m reel except for tight-buffer OM4
 Tight-buffer: "easy strip"
 Other configurations on request

Pack	Cat.Nos		Single-mode OS2 fiber optic cables (9/125 μm) - (OS1 compatible) For 9/125 μm single-mode installations, OS2 type Indoor/Outdoor Yellow LSZH sheath Glass strands 4 fibers - Euroclass Dca 6 fibers - Euroclass Dca 8 fibers - Euroclass Dca 12 fibers - Euroclass Dca 12 fibers - Euroclass Cca 24 fibers - Euroclass Dca Outdoor Black PE sheath Glass strands for rodent-proofing, reinforced with corrugated steel 4 fibers 6 fibers 8 fibers 12 fibers 24 fibers
	Loose tube	Tight-buffer 900 μm	
2000 ¹	0 325 02	0 325 50	
2000 ¹	0 325 12		
2000 ¹	0 325 03		
2000 ¹	0 325 14		
2000 ¹	0 325 26		
2000 ¹	0 325 51		
2000 ¹	0 325 23		
2000 ¹	0 325 13		
2000 ¹	0 325 24		
2000 ¹	0 325 15		
2000 ¹	0 325 25		

Pack	Cat.Nos		Multimode OM3 fiber optic cables (50/125 μm) For 50/125 μm multimode installations, OM3 type Suitable for 10 Gb Ethernet networks Bend insensitive Indoor/Outdoor Aqua LSZH sheath Glass strands Euroclass Dca 4 fibers 6 fibers 8 fibers 12 fibers 24 fibers Outdoor Black PE sheath Glass strands for rodent-proofing, reinforced with corrugated steel 8 fibers 12 fibers 24 fibers
	Loose tube	Tight-buffer 900 μm	
2000 ¹	0 325 37	0 325 10	
2000 ¹	0 325 38		
2000 ¹	0 325 39		
2000 ¹	0 325 53		
2000 ¹	0 325 52		
2000 ¹	0 325 40		
2000 ¹	0 325 41		
2000 ¹	0 325 42		

1: in metre(s)

Pack	Cat.Nos		Multimode OM4 fiber optic cables (50/125 μm) For 50/125 μm multimode installations, OM4 type Suitable for 10 Gb Ethernet networks Bend insensitive Indoor/Outdoor Aqua LSZH sheath Glass strands 4 fibers - Euroclass Dca 6 fibers - Euroclass Dca - 500 m drum 6 fibers - Euroclass Dca - 1000 m drum 8 fibers - Euroclass Dca 12 fibers - Euroclass Dca 12 fibers - Euroclass Cca 12 fibers - Euroclass Dca - 1000 m drum 24 fibers - Euroclass Dca - 1000 m drum Outdoor Black PE sheath Glass strands for rodent-proofing, reinforced with corrugated steel 4 fibers 8 fibers 12 fibers
	Loose tube	Tight-buffer 900 μm	
2000 ¹	0 325 43	0 326 65	
500 ¹			
1000 ¹		0 326 66	
2000 ¹			
2000 ¹			
2000 ¹			
2000 ¹	0 325 44	0 326 67	
2000 ¹			
2000 ¹	0 325 45	0 326 68	
2000 ¹			
1000 ¹	0 325 49		
1000 ¹			
2000 ¹	0 325 46		
2000 ¹	0 325 47		
2000 ¹	0 325 48		

Legrand cabling system, LCS³ fiber optic preterminated links

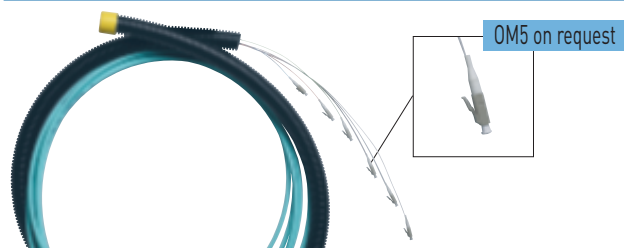

1 320 41

Selection chart p.22-23

Supplied with pulling element. In coil up to 50 m, on a small drum between 51 m and 150 m, on a large drum over 151 m and up to 200 m
Connection in fiber optic drawers. OM3 aqua LSZH sheaths. Supplied with test reports

Possible to obtain customised preterminated links: cable type, structure, length, connector type, etc

Pack Cat.Nos SC/SC tight-buffer OM3 links

6 SC simplex - 6 SC simplex

1	1 320 01	Length 10 m
1	1 320 02	Length 20 m
1	1 320 03	Length 30 m
1	1 320 04	Length 40 m
1	1 320 05	Length 50 m
1	1 320 06	Length 60 m
1	1 320 07	Length 70 m
1	1 320 08	Length 80 m
1	1 320 09	Length 90 m
1	1 320 10	Length 100 m
1	1 320 12	Length 120 m
1	1 320 14	Length 140 m
1	1 320 16	Length 160 m
1	1 320 18	Length 180 m
1	1 320 20	Length 200 m

12 SC simplex - 12 SC simplex

1	1 320 21	Length 10 m
1	1 320 22	Length 20 m
1	1 320 23	Length 30 m
1	1 320 24	Length 40 m
1	1 320 25	Length 50 m
1	1 320 26	Length 60 m
1	1 320 27	Length 70 m
1	1 320 28	Length 80 m
1	1 320 29	Length 90 m
1	1 320 30	Length 100 m
1	1 320 32	Length 120 m
1	1 320 34	Length 140 m
1	1 320 36	Length 160 m
1	1 320 38	Length 180 m
1	1 320 40	Length 200 m

Pack Cat.Nos LC/LC tight-buffer OM3 links

6 LC simplex - 6 LC simplex

1	1 320 41	Length 10 m
1	1 320 42	Length 20 m
1	1 320 43	Length 30 m
1	1 320 44	Length 40 m
1	1 320 45	Length 50 m
1	1 320 46	Length 60 m
1	1 320 47	Length 70 m
1	1 320 48	Length 80 m
1	1 320 49	Length 90 m
1	1 320 50	Length 100 m
1	1 320 52	Length 120 m
1	1 320 54	Length 140 m
1	1 320 56	Length 160 m
1	1 320 58	Length 180 m
1	1 320 60	Length 200 m

12 LC simplex - 12 LC simplex

1	1 320 61	Length 10 m
1	1 320 62	Length 20 m
1	1 320 63	Length 30 m
1	1 320 64	Length 40 m
1	1 320 65	Length 50 m
1	1 320 66	Length 60 m
1	1 320 67	Length 70 m
1	1 320 68	Length 80 m
1	1 320 69	Length 90 m
1	1 320 70	Length 100 m
1	1 320 72	Length 120 m
1	1 320 74	Length 140 m
1	1 320 76	Length 160 m
1	1 320 78	Length 180 m
1	1 320 80	Length 200 m

Legrand cabling system, LCS³ fiber optic High Density preterminated links



0 324 41

Selection chart p.22-23

Supplied on a drum
Micro cables for high density cassettes
Aqua (OM3) and yellow (OS2) LSZH sheaths
Supplied with test reports (photometry)
Other configurations on request

Pack Cat.Nos Fan-out/Fan-out preterminated High Density fiber optic links

With fan-out (2 mm output) for secure transition between the cable and the ends
Low insertion loss for LC connector < 0.15 dB/connector

Fan-out/Fan-out OM3 micro cables

	Description	Length (m)
1	0 324 01	6 LC duplex - 6 LC duplex 10
1	0 324 02	6 LC duplex - 6 LC duplex 20
1	0 324 03	6 LC duplex - 6 LC duplex 30
1	0 324 04	6 LC duplex - 6 LC duplex 40
1	0 324 05	6 LC duplex - 6 LC duplex 50
1	0 324 11	12 LC duplex - 12 LC duplex 10
1	0 324 12	12 LC duplex - 12 LC duplex 20
1	0 324 13	12 LC duplex - 12 LC duplex 30
1	0 324 14	12 LC duplex - 12 LC duplex 40
1	0 324 15	12 LC duplex - 12 LC duplex 50

Fan-out/Fan-out OS2 micro cables

	Description	Length (m)
1	0 324 21	6 LC duplex - 6 LC duplex 10
1	0 324 22	6 LC duplex - 6 LC duplex 20
1	0 324 23	6 LC duplex - 6 LC duplex 30
1	0 324 24	6 LC duplex - 6 LC duplex 40
1	0 324 25	6 LC duplex - 6 LC duplex 50
1	0 324 31	12 LC duplex - 12 LC duplex 10
1	0 324 32	12 LC duplex - 12 LC duplex 20
1	0 324 33	12 LC duplex - 12 LC duplex 30
1	0 324 34	12 LC duplex - 12 LC duplex 40
1	0 324 35	12 LC duplex - 12 LC duplex 50

MTP¹/MTP¹ High Density preterminated fiber optic links

For connecting cassettes in High Density fiber optic panels and Ultra High Density drawers
Female MTP¹, A polarity
Low insertion loss for MTP¹ connector < 0.35 dB/connector

MTP¹ OM3 micro cables

	Description	Length (m)
1	0 324 41	12 MTP ¹ -MTP ¹ fiber optics 10
1	0 324 42	12 MTP ¹ -MTP ¹ fiber optics 20
1	0 324 43	12 MTP ¹ -MTP ¹ fiber optics 30
1	0 324 44	12 MTP ¹ -MTP ¹ fiber optics 40
1	0 324 45	12 MTP ¹ -MTP ¹ fiber optics 50

MTP¹ OS2 micro cables

	Description	Length (m)
1	0 324 51	12 MTP ¹ -MTP ¹ fiber optics 10
1	0 324 52	12 MTP ¹ -MTP ¹ fiber optics 20
1	0 324 53	12 MTP ¹ -MTP ¹ fiber optics 30
1	0 324 54	12 MTP ¹ -MTP ¹ fiber optics 40
1	0 324 55	12 MTP ¹ -MTP ¹ fiber optics 50

1: MTP¹ is a registered trademark of US Conec Ltd

Legrand cabling system, LCS³ fiber optic

19" fiber optic drawers

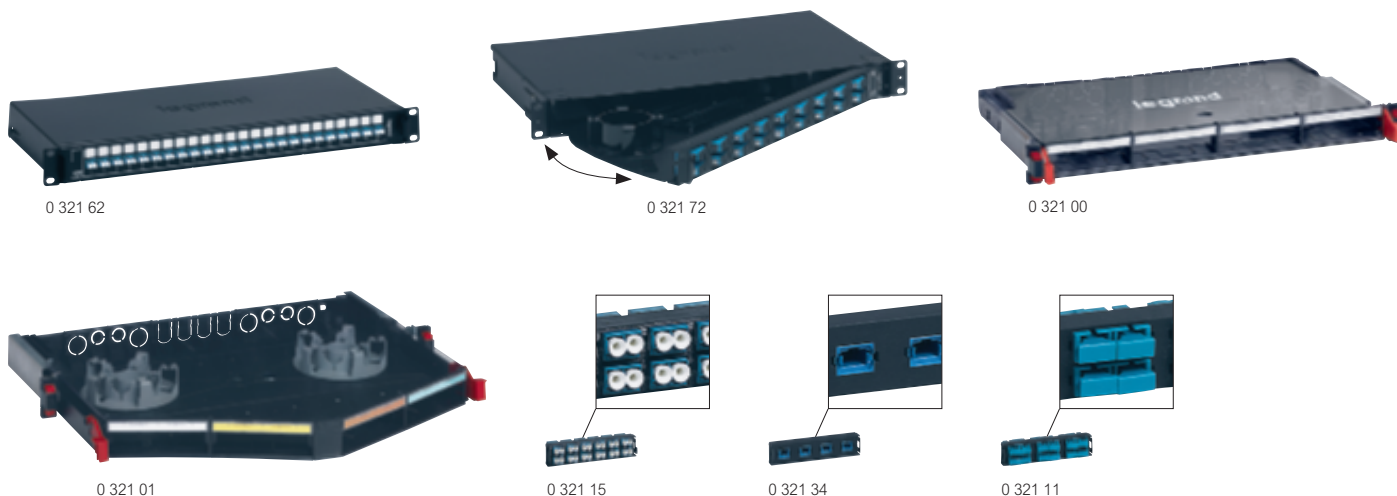

Selection chart p.14-15

Pack	Cat.Nos	Equipped 19" fiber optic drawers
		Metal 19" pre-equipped fiber optic drawers, 4 cable entries, supplied with screw fixing kit, 2 cable glands (Ø 13.5 and 16 mm), coiling system and splice cassette Panel and optical ports marked on dedicated marking area
		Sliding End stop at a 30° angle Maximum capacity: 48 fibers in LC version, 24 fibers in ST and SC versions Depth 220 mm, height 1 U
1	0 321 61	SC duplex for 24 multimode fibers
1	0 321 62	LC duplex for 48 multimode fibers
1	0 321 63	ST duplex for 24 multimode fibers
1	0 321 64	SC duplex for 24 single-mode fibers
1	0 321 65	LC duplex for 48 single-mode fibers
1	0 321 66	SC APC duplex for 24 single-mode fibers
1	0 321 67	LC APC duplex for 48 single-mode fibers
		Rotating Supplied with reversible left or right opening Maximum capacity: 72 fibers in LC version, 36 fibers in SC version Depth 260 mm, height 1 U
1	0 321 71	LC duplex for 72 multimode fibers
1	0 321 72	SC duplex for 36 multimode fibers
1	0 321 73	LC duplex for 72 single-mode fibers
1	0 321 74	SC duplex for 36 single-mode fibers

Pack	Cat.Nos	Flat and angled 19" modular fiber optic drawers
		Metal 19" modular fiber optic drawers, 8 cable entries, supplied with 2 cable glands (Ø 13.5 and 9 mm), coiling system Equipped with the new-generation Quick-Fix system for automatic (screwless) mounting on enclosure or cabinet uprights Supplied with numbered labels Maximum capacity: 96 fibers in LC version, 48 in SC version or 24 in ST version Depth 290 mm, height 1U
		Sliding, equipped End stop at a 20° angle
1	0 321 02	SC duplex for 24 multimode fibers
1	0 321 04	LC duplex for 48 multimode fibers
1	0 321 06	SC duplex for 24 single-mode fibers
		Sliding, to be equipped with fiber optic blocks Takes any fiber optic block, up to 4 blocks maximum. End stop at a 20° angle
1	0 321 00	Empty drawer
		Sliding, to be equipped with fiber optic blocks - angled Takes any fiber optic block, up to 4 blocks maximum. End stop at a 20° angle
1	0 321 01	Empty drawer

Pack	Cat.Nos	Fiber optic blocks
		To be clipped directly onto modular fiber optic drawers to be equipped Cat. Nos 0 321 00/01 or onto fiber optic splice cassette Cat. No 0 321 41
		Single-mode fiber blocks (9/125 µm)
1	0 321 17	ST block for 6 single-mode fibers
1	0 321 10	SC duplex block for 6 single-mode fibers
1	0 321 11	SC duplex High Density block for 12 single-mode fibers
1	0 321 12	SC APC duplex block for 6 single-mode fibers
1	0 321 13	LC duplex block for 6 single-mode fibers
1	0 321 14	LC duplex block for 12 single-mode fibers
1	0 321 15	LC duplex High Density block for 24 single-mode fibers
1	0 321 16	LC APC duplex block for 12 single-mode fibers
1	0 321 33	Single-mode 4 MTP ¹ feedthrough adaptor, key up/ key down
1	0 321 19	Single-mode 8 MTP ¹ feedthrough adaptor, key up/ key down
		Multimode fiber blocks (62.5 and 50/125 µm)
1	0 321 27	ST block for 6 multimode fibers
1	0 321 20	SC duplex block for 6 multimode fibers
1	0 321 21	SC duplex High Density block for 12 multimode fibers
1	0 321 23	LC duplex block for 6 multimode fibers
1	0 321 24	LC duplex block for 12 multimode fibers
1	0 321 25	LC duplex High Density block for 24 multimode fibers
1	0 321 34	Multimode 4 MTP ¹ feedthrough adaptor, key up/ key down
1	0 321 18	Multimode 8 MTP ¹ feedthrough adaptor, key up/ key down
1	0 321 36	LC duplex block for 6 multimode fibers - aqua
1	0 321 37	LC duplex block for 12 multimode fibers - aqua

Pack	Cat.Nos	RJ45 copper block for fiber optic drawer
1	0 321 32	To be clipped directly onto modular fiber optic drawers to be equipped Cat. Nos 0 321 00/01 Allows the mixing of fiber optic and copper Takes up to 5 RJ45 connectors

Pack	Cat.Nos	Accessories for fiber optic drawer to be equipped
		Accessory for receipt of a fan-out To be clipped onto the back of the drawer Enables the entry of preterminated links
1	0 321 28	
		Blanking plate Blanking plate
1	0 321 29	
		Cassette for pigtails Capacity: 24 fibers
1	0 321 30	
		Coiling kit 1 accessory
1	0 321 31	

1: MTP is a registered trademark of US Conec Ltd

Legrand cabling system, LCS³ fiber optic

19" High Density fiber optic panels (1/2/4 U) and patching kits

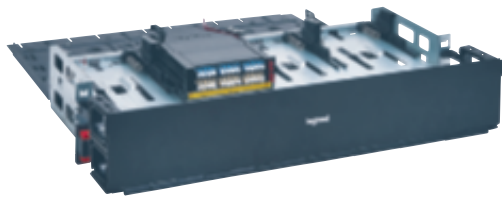

Panel 0 321 76 equipped with support 0 321 38 and slim cassettes 0 321 69/70

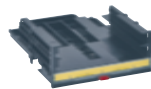

0 321 38



0 321 69



0 321 70



Selection chart p.16-17

Pack	Cat.Nos	19" High Density fiber optic panels	Pack	Cat.Nos	Preterminated MTP ¹ High Density cassettes (MPO compatible) (continued)
		Panels to be equipped with cassettes Equipped with Quick-Fix system for automatic (screwless) mounting on enclosure or cabinet uprights To be equipped directly with a maximum of 4 automatically removable cassettes or 4 supports for slim cassettes Cat. No 0 321 38 per U Maximum capacity per U: 48 fibers in SC version, 24 fibers in ST version or 96 fibers in LC version 2U and 4U versions equipped with door and cord management at the front, and with cable management at the back			Preterminated MTP¹ High Density cassettes (MPO compatible) (continued)
1	0 321 75	1 U height, depth 182 mm	1	0 321 38	Slim cassettes Support for High Density slim cassettes Takes up to 2 High Density slim cassettes Cat.Nos 0 321 68/69/70 and up to 2 blanking cassettes Cat.No 0 321 39 or 1 cassette + 1 blanking cassette Possibility to mix slim single-mode and multimode cassettes on the same support
1	0 321 76	2 U height, depth 393 mm	1	0 321 69	Slim multimode OM4 cassette (50/125 μm) 12 LC fibers, Universal polarity
1	0 321 77	4 U height, depth 393 mm	1	0 321 68	Slim multimode OM3 cassette (50/125 μm) 12 LC fibers, Universal polarity
		Accessories for panels	1	0 321 70	Slim single-mode OS2 cassette (9/125 μm) 12 LC fibers, Universal polarity
1	0 321 78	Front cord management kit for 1 U panel Fits on 1 U modular panel Cat.No 0 321 75 2 side cord guides and front door with integrated marking to ensure correct front and side cord management Cord holder to be mounted on cassette to make it easier to pass cords through the side	1	0 321 39	Slim blanking module to be mounted (x2) on support Cat.No 0 321 38 to fill gaps in the panel
1	0 321 46	Rear cable management accessory Fits on 1 U panel Cat. No 0 321 75			Pre-equipped cassettes For installation in modular panels Cat. Nos 0 321 75/76/77 and Zero-U kit Cat.No 0 321 03 Pre-equipped cassettes with fitted fiber optic block + sets of 6 or 12 OM3 pigtails Sliding cassettes which can be removed automatically by simply pressing them, simplifying installation and maintenance Removable from the front
1	0 321 28	Accessory for receipt of a fan-out To be clipped onto the back of the drawer Enables the entry of preterminated links			Pre-equipped cassettes for multimode installation (50/125 μm) Equipped with 1 SC duplex block for 6 fibers Equipped with 1 LC duplex block for 6 fibers Equipped with 1 SC duplex block for 12 fibers Equipped with 1 LC duplex block for 12 fibers
1	0 321 22	Copper cable management accessory	1	0 321 80	Pre-equipped cassettes for single-mode installation (9/125 μm) Equipped with 1 SC duplex block for 6 fibers Equipped with 1 LC duplex block for 6 fibers Equipped with 1 SC duplex block for 12 fibers Equipped with 1 LC duplex block for 12 fibers
1	0 321 26	Set of 4 cord holders To be mounted on any cassette to make it easier to pass cords through the side	1	0 321 81	
1	0 321 05	Rear accessory for fixing 4 cable glands	1	0 321 82	
		Preterminated MTP¹ High Density cassettes (MPO compatible) For installation in modular panels Cat. Nos 0 321 75/76/77 and in Zero-U kit Cat. No 0 321 03 Slim cassettes to be installed with support Cat. No 0 321 38 Sliding cassettes which can be removed automatically by simply pressing them, simplifying installation and maintenance Removable from the front and back High-performance MTP ¹ cassettes, low insertion loss < 0.5 dB Prewired, equipped at the rear with one or two male MTP ¹ connectors with 12 fibers LC or SC connectors at the front	1	0 321 83	
1	0 321 42	Cassettes Multimode OM4 cassette (50/125 μm) 24 LC fibers, A/C polarity	1	0 321 84	
1	0 321 48	Multimode OM4 cassette (50/125 μm) 12 LC fibers, A/C polarity	1	0 321 85	
1	0 321 43	Multimode OM4 cassette (50/125 μm) 12 SC fibers, A/C polarity	1	0 321 86	
1	0 321 59	Multimode OM4 cassette (50/125 μm) 12 SC fibers, universal	1	0 321 87	
1	0 321 44	Single-mode OS2 cassette (9/125 μm) 24 LC fibers, A/C polarity			Cassettes to be equipped and blanking plate For installation in modular panels Cat. Nos 0 321 75/76/77 and Zero-U kit Cat.No 0 321 03 Sliding cassettes which can be removed automatically by simply pressing them, simplifying installation and maintenance Removable from the front
1	0 321 49	Single-mode OS2 cassette (9/125 μm) 12 LC fibers, A/C polarity	1	0 321 41	Fiber optic splice cassette Takes any modular fiber optic block (p.26)
1	0 321 45	Single-mode OS2 cassette (9/125 μm) 12 SC fibers, A/C polarity	1	0 337 57	Blanking cassette To be used to fill gaps in the panel
1	0 321 60	Single-mode OS2 cassette (9/125 μm) 12 SC fibers, universal	1	0 321 55	Copper cassette to be equipped Takes six Cat. 5e, 6 and 6A copper connectors
					Patching kits
					1 U to 4 U patching kit Compatible with all LCS ³ fiber optic and copper 19" panels Supplied with top protection, cable guides and specific accessories for installation on cable trays, wire meshed cable trays (Cablofil) and cabinets
					Zero-U patching kit To bring few fiber optic or copper connections outside 19" panels Takes 1 cassette (fiber optic preterminated cassettes, pre equipped cassettes, fiber optic splice cassette or RJ45 copper cassette) Supplied with a comprehensive range of accessories for fixing in or outside enclosures (raised access floors, cable trays, walls, ceiling)

1: MTP is a registered trademark of US Conec Ltd

Legrand cabling system, LCS³ fiber optic

19" Ultra High Density fiber optic drawers

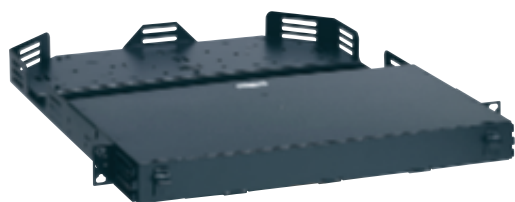

0 321 50

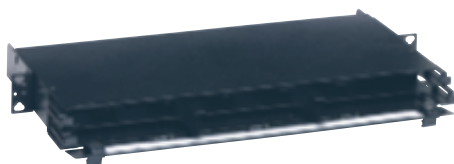

0 321 90

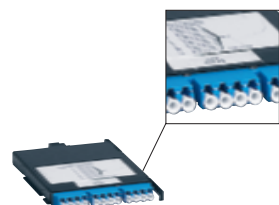

0 321 55

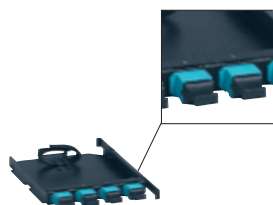

0 321 56

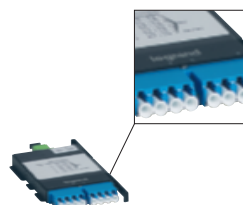

0 321 94

Selection chart p.18-19

Pack	Cat.Nos	Ultra High Density modular fiber optic drawers, to be equipped with 12-fiber cassettes
1	0 321 51	<p>Fixed modular chassis for holding cassettes</p> <p>4 U maximum capacity (holds up to 48 cassettes): 576 LC fibers</p> <p>2 U maximum capacity (holds up to 24 cassettes): 288 LC fibers</p> <p>1 U maximum capacity (holds up to 12 cassettes): 144 LC fibers</p> <p>Fiber optic drawer with cord management at the front for 12-fiber cassettes</p> <p>1 U</p> <p>Fiber optic drawers with cord management at the front and back for 12-fiber cassettes</p> <p>Depth: 595 mm</p>
1	0 321 50	1 U
1	0 321 52	2 U
1	0 321 53	4 U
		Ultra High Density 12-fiber cassettes
		<p>Clip directly into fiber optic drawers</p> <p>Cat. Nos. 0 321 50/51/52/53</p> <p>Cassettes slide into above chassis</p> <p>Cassettes can be removed from the front and back</p> <p>MPO high-performance cassettes</p> <p>Low insertion loss < 0.35 dB</p> <p>A/C polarity</p>
1	0 321 54	<p>Multimode OM4 cassettes (50/125 μm)</p> <p>For 50/125 μm multimode installation, OM4 type</p> <p>MPO cassette (MTP¹ compatible)</p> <p>12 OM4 LC fibers, polarity A/C</p>
1	0 321 55	<p>Single-mode OS2 cassette (9/125 μm)</p> <p>For 9/125 μm single-mode installation, OS2 type</p> <p>MPO cassette (MTP¹ compatible)</p> <p>12 OS2 LC fibers, polarity A/C</p>
		Adaptors for 12-fiber Ultra High Density installation
		<p>Clip into Ultra High Density fiber optic drawers for 12-fiber cassettes Cat. Nos 0 321 50/51/52/53</p>
		MPO adaptors (MTP¹ compatible)
1	0 321 56	Multimode 4 MTP adaptor - key up/key down
1	0 321 57	Single-mode 4 MTP adaptor - key up/key down
		LC adaptor
1	0 321 58	12 LC multimode adaptor

Pack	Cat.Nos	Ultra High Density modular fiber optic drawers, to be equipped with 8-fiber cassettes
1	0 321 90	<p>Fixed modular chassis for holding cassettes</p> <p>4 U maximum capacity (holds up to 72 cassettes): - 576 LC fibers</p> <p>2 U maximum capacity (holds up to 36 cassettes): - 288 LC fibers</p> <p>1 U maximum capacity (holds up to 18 cassettes) - 144 LC fibers</p> <p>Fiber optic drawers with cord management at the front and back for 8-fiber cassettes</p> <p>Depth: 595 mm</p>
1	0 321 91	1 U
1	0 321 92	2 U
1	0 321 92	4 U
		Ultra High Density 8-fiber cassettes
		<p>Clip directly into fiber optic drawers</p> <p>Cat. Nos. 0 321 90/91/92</p> <p>Cassettes slide into above chassis</p> <p>Cassettes can be removed from the front and back</p> <p>MPO high-performance cassettes</p> <p>Low insertion loss < 0.35 dB</p> <p>Universal polarity</p>
1	0 321 93	<p>Multimode OM4 cassettes (50/125 μm)</p> <p>For 50/125 μm multimode installation, OM4 type</p> <p>MPO cassette (MTP¹ compatible)</p> <p>8 OM4 LC fibers, universal polarity</p>
1	0 321 94	<p>Single-mode OS2 cassette (9/125 μm)</p> <p>For 9/125 μm single-mode installation, OS2 type</p> <p>MPO cassette (MTP¹ compatible)</p> <p>8 OS2 LC fibers, universal polarity</p>
		Adaptors for 8-fiber Ultra High Density installation
		<p>Clip into Ultra High Density fiber optic drawers for 8-fiber cassettes Cat. Nos 0 321 90/91/92</p>
		MPO adaptors (MTP¹ compatible)
1	0 321 95	Multimode 4 MTP ¹ adaptor - key up/key down
1	0 321 96	Single-mode 4 MTP ¹ adaptor - key up/key down
		LC adaptors
1	0 321 97	8 LC multimode adaptor
1	0 321 98	8 LC single-mode adaptor
1	0 321 99	8 LC-APC single-mode adaptor

1: MTP is a registered trademark of US Conec zLtd

Legrand cabling system, LCS³ fiber optic pigtails, glue-on connectors and fan-out units

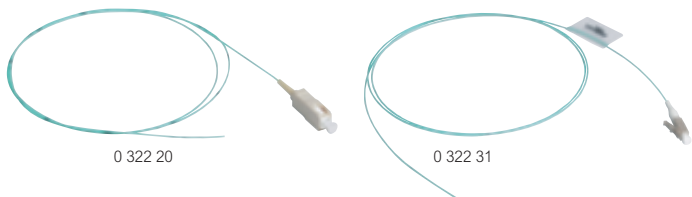

Selection chart p.20-21

Pack	Cat.Nos		Pigtails
			LSZH For making quick, reliable and high-performance fiber optic cable connections on site: - OM2/OM3/OM4 IL Typical/Master = 0.15 dB - OS2 IL Typical/Master = 0.18 dB Compatible with all commercially-available splicers
			50/125 µm - OM2 (PC)
1	0 322 10	0 322 13	SC connectors
1	0 322 11	0 322 14	LC connectors
1	0 322 12	0 322 15	ST connectors
			50/125 µm - OM3 (PC)
1	0 322 20	0 322 23	SC connectors
1	0 322 21	0 322 24	LC connectors
1	0 322 22		ST connectors
			50/125 µm - OM4 (PC)
1	0 322 30	0 322 33	SC connectors
1	0 322 31	0 322 34	LC connectors
1	0 322 32		ST connectors
			9/125 µm - OS2 (APC or UPC) - OS1 compatible
1	0 322 40	0 322 45	SC-APC connectors
1	0 322 41	0 322 46	SC-UPC connectors
1	0 322 42	0 322 48	LC-APC connectors
1	0 322 43	0 322 47	LC-UPC connectors
1	0 322 44	0 322 49	ST-UPC connectors
			Sets of 12 LC pigtails
1	0 326 24		1m length - 12 different colors
1	0 326 26		12 OS2 LC-UPC pigtails
1	0 326 71		12 OM3 LC-UPC pigtails 12 OM4 LC-UPC pigtails
			Heat-shrinkable sleeve for pigtails
1	0 327 44		40 mm - pack of 50 sleeves
			50/125 and 62,5/125 µm glue-on connectors
			Supplied with 900 µm sleeve Connectors with ceramic ferrule Typical attenuation: 0.3 dB
10	0 331 27		ST connectors
10	0 331 47		SC connectors
10	0 331 00		LC connectors
			Fan-out units
			For 900 µm sheathing of optical fibers Take 250 µm fiber diameters
1	0 330 48		6-fiber fan-out unit
1	0 330 49		12-fiber fan-out unit

Legrand cabling system, LCS³ fiber optic case and quick-connect connectors

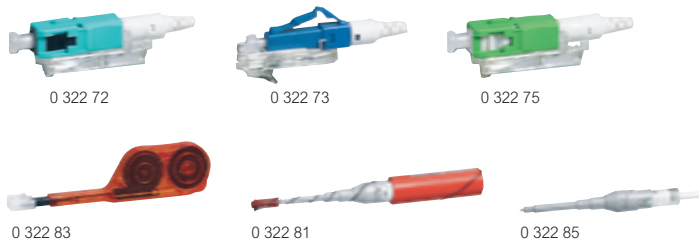
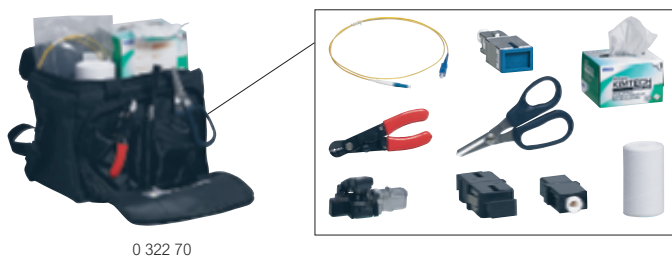

Pack	Cat.Nos	Tool case for preparing optical fiber for quick-connect fiber optic connectors
1	0 322 70	Provides the tools required for preparing optical cables, for carrying out initial tests of the connection of fibers to connectors and accessories for easy connection in all situations Comprises: - Precision cleaver - Kevlar stripping and cutting tool - Visual fault locator - Installation instructions and video - Accessories (cleaners, felt tip pen, bin, etc)
		Quick-connect connectors
		Connection can be made with case Cat.No 0 322 70 Quick-connect, reliable and reusable up to 5 times To be used to lock the fiber inside the connector An indicator light is used to test the connection No glue or polishing needed Can be installed on 900 µm fiber optics For 250 µm fiber, use the special tubes supplied with the connectors; typical IL: multimode OM3/OM4 = 0.1 dB and single-mode OS2 = 0.2 dB (PC) and 0.3 dB (APC)
		OM3/OM4 multimode connectors
		Set of 12 connectors
1	0 322 71	LC PC 50/125 µm, 900/250 µm
1	0 322 72	SC PC 50/125 µm, 900/250 µm
		OS2 single-mode connectors
		Set of 12 connectors
1	0 322 73	LC UPC 9/125 µm, 900/250 µm
1	0 322 74	SC UPC 9/125 µm, 900/250 µm
1	0 322 75	SC APC 9/125 µm, 900/250 µm
		Precision cleaver for updating case Cat. No 0 326 90
1	0 322 80	Enables precision-cutting of fiber optics and the use of quick-connect connectors Cat. Nos 0 322 71 to 0 322 75 with case Cat. No 0 326 90
		Fiber optic cleaning accessories
1	0 322 83	MPO/MTP ¹ ferrule cleaner
1	0 322 81	LC ferrule cleaner (PC/APC)
1	0 322 82	SC ferrule cleaner (PC/APC)
1	0 322 84	LC replacement cartridge
1	0 322 85	SC replacement cartridge
1	0 322 76	Fiber stripper
1	0 322 77	Wipes
1	0 322 78	Cleaning spray

1: MTP is a registered trademark of US Conec LtdWW

Legrand cabling system, LCS³ fiber optic

patch cords and feedthrough sockets



Selection chart p.20-21

Fitted at each end with 2 connectors with ceramic ferrule. Individually packed and tested (report supplied). LSZH Zipcord sheath
Other configurations on request

Pack	Cat.Nos	OS1/OS2 single-mode fiber optic cords (9/125 μm)
		Max. optical losses/Master: 0.25 dB For 9/125 μm single-mode installations, OS1/OS2 type. Yellow sheaths
		SC/SC duplex cords
3	0 326 00	Length: 1 m
3	0 326 01	Length: 2 m
3	0 326 02	Length: 3 m
		SC/LC duplex cords
3	0 326 03	Length: 1 m
3	0 326 04	Length: 2 m
3	0 326 05	Length: 3 m
		LC/LC duplex cords
3	0 326 28	Length: 0.5 m
3	0 326 06	Length: 1 m
3	0 326 07	Length: 2 m
3	0 326 08	Length: 3 m
3	0 326 29	Length: 5 m
		LC/LC Uniboot duplex cords
		Reversible polarity
3	0 326 86	Length: 1 m
3	0 326 87	Length: 2 m
3	0 326 88	Length: 3 m
3	0 326 89	Length: 5 m
3	0 326 92	Length: 10 m

Pack	Cat.Nos	OM4 multimode fiber optic cords (50/125 μm)
		Suitable for 10 Gb Ethernet networks Max. optical losses/Master: 0.15 dB For 50/125 μm multimode installation, OM4 type Aqua sheaths
		SC/SC duplex cords
3	0 326 30	Length: 1 m
3	0 326 31	Length: 2 m
3	0 326 32	Length: 3 m
		LC/LC duplex cords
3	0 326 33	Length: 0.5 m
3	0 326 34	Length: 1 m
3	0 326 35	Length: 2 m
3	0 326 36	Length: 3 m
3	0 326 37	Length: 5 m
		LC/LC Uniboot duplex cords
		Reversible polarity
3	0 326 95	Length: 1 m
3	0 326 96	Length: 2 m
3	0 326 97	Length: 3 m
3	0 326 98	Length: 5 m
3	0 326 99	Length: 10 m

Pack	Cat.Nos	OM3 multimode fiber optic cords (50/125 μm)
		Suitable for 10 Gb Ethernet networks Max. optical losses/Master: 0.25 dB For 50/125 μm multimode installation, OM3 type Aqua sheaths
		SC/SC duplex cords
3	0 326 09	Length: 1 m
3	0 326 10	Length: 2 m
3	0 326 11	Length: 3 m
		SC/LC duplex cords
3	0 326 12	Length: 1 m
3	0 326 13	Length: 2 m
3	0 326 14	Length: 3 m
		LC/LC duplex cords
3	0 326 15	Length: 1 m
3	0 326 16	Length: 2 m
3	0 326 17	Length: 3 m

Pack	Cat.Nos	OM2 multimode fiber optic cords (50/125 μm)
		Max. optical losses/Master: 0.25 dB For 50/125 μm multimode installation, OM2 type Orange sheaths
		ST/ST duplex cords
3	0 330 80	Length: 1 m
3	0 330 81	Length: 2 m
3	0 330 82	Length: 3 m
		SC/SC duplex cords
3	0 330 69	Length: 1 m
3	0 330 70	Length: 2 m
3	0 330 71	Length: 3 m
		ST/SC duplex cords
3	0 330 72	Length: 2 m
3	0 330 73	Length: 3 m
		LC/LC duplex cord
3	0 330 61	Length: 2 m
		SC/LC duplex cords
3	0 330 75	Length: 1 m
3	0 330 63	Length: 2 m
3	0 330 76	Length: 3 m
		LC/ST duplex cord
3	0 330 65	Length: 2 m

Pack	Cat.Nos	Fiber optic feedthrough sockets
		Equipped with a duplex feedthrough To be used to connect two fibers (equipped with their connector) Supplied with protection caps Equipped with a transparent marker-holder 2 modules
		2 x ST socket
1	0 786 16	Bayonet connection (STII compatible) ○ White
		2 x SC socket
1	0 786 17	Push-pull connection ○ White
		2 x LC socket
1	0 786 18	Push-pull connection ○ White
		2 x SC/APC socket
1	0 786 14	Push-pull connection With shutters ○ White

Legrand cabling system, LCS³ fiber optic

Duplex applications, functioning on Duplex LC

Duplex	OM3	OM4	OM5	OS1a	OS2
10Gbps	300m ⁽¹⁾	400m ⁽¹⁾	400m ⁽¹⁾	2km ⁽¹⁾	10km ⁽¹⁾
25Gbps	70m ⁽¹⁾	100m ⁽¹⁾	100m ⁽¹⁾	2km ⁽¹⁾	10km ⁽¹⁾
40Gbps	240m ⁽²⁾	350m ⁽²⁾	440m ⁽²⁾	2km ⁽¹⁾	10km ⁽¹⁾
50Gbps	70m ⁽¹⁾	100m ⁽¹⁾	100m ⁽¹⁾	2km ⁽¹⁾	10km ⁽¹⁾
100Gbps	70m ⁽²⁾	100m ⁽²⁾	150m ⁽²⁾	2km ⁽¹⁾	10km ⁽¹⁾
200Gbps	N/A ⁽³⁾	N/A ⁽³⁾	N/A ⁽³⁾	2km ⁽¹⁾	10km ⁽¹⁾
400Gbps	N/A ⁽³⁾	N/A ⁽³⁾	N/A ⁽³⁾	2km ⁽¹⁾	10km ⁽¹⁾

1: Standard
2: Multi-Source Agreement
3: Not applicable

Parallel optics applications, functioning on 12-core MPO/MTP

Parallel	OM3	OM4	OM5	OS1a	OS2
10Gbps	N/A ⁽²⁾	N/A ⁽²⁾	N/A ⁽²⁾	N/A ⁽²⁾	N/A ⁽²⁾
25Gbps	N/A ⁽²⁾	N/A ⁽²⁾	N/A ⁽²⁾	N/A ⁽²⁾	N/A ⁽²⁾
40Gbps	100m ⁽¹⁾	150m ⁽¹⁾	150m ⁽¹⁾	N/A ⁽²⁾	N/A ⁽²⁾
50Gbps	N/A ⁽²⁾	N/A ⁽²⁾	N/A ⁽²⁾	N/A ⁽²⁾	N/A ⁽²⁾
100Gbps	70m ⁽¹⁾	100m ⁽¹⁾	100m ⁽¹⁾	500m ⁽¹⁾	500m ⁽¹⁾
200Gbps	70m ⁽¹⁾	100m ⁽¹⁾	100m ⁽¹⁾	500m ⁽¹⁾	500m ⁽¹⁾
400Gbps	100m ⁽¹⁾	100m ⁽¹⁾	150m ⁽¹⁾	500m ⁽¹⁾	500m ⁽¹⁾

1: Standard
2: Not applicable

16, 20 and 32 core applications not shown as they are not compatible with single 12-core MPO links
Note that any duplex application can also function on MPO/MTP parallel optics infrastructure

Technical characteristics

Pigtail

Insertion loss (IL), dB	Multimode	Singlemode
IL max. against Master. Standard	0.60	0.65
IL max. against Master. Legrand guarantee	0.25	0.25
IL max. against Random. Standard	0.75	0.75
IL typical against Random. Legrand guarantee	0.20	0.18

Multimode cable

OM5 fiber is designed for wavelength multiplexing

Type of cable	OM3	OM4	OM5
Type of fiber ¹	A1a.2	A1a.3	A1a.4
Maximum attenuation at 850 nm, dB/km	3.5	3.5	3
Effective bandwidth at 850 nm, MHz x km	2000	4700	4700
Effective bandwidth at 953 nm, MHz x km	N/A	N/A	2470

1: According to IEC 60793-2-10

Single-mode cable

Type of cable	OS1a	OS2
Environment	Indoor	Indoor/ Outdoor
Type of fiber ⁽¹⁾	B1,3 or B6	
Maximum attenuation at 1310, 1383 and 1550 nm	1.0	0.4

1: According to IEC 60793-2-50

Euroclass table

Cat.Nos	Euroclass (A _{ca} ; B1 _{ca} ; B2 _{ca} ; C _{ca} ; D _{ca} ; E _{ca} ; F _{ca})	Additional criteria (smoke production, flaming droplets, acidity)		
		s1, s1a, s1b, s2, s3	d0, d1, d2	a1, a2, a3
0 325 02	D _{ca}	s2	d2	a1
0 325 03	D _{ca}	s2	d2	a1
0 325 10	D _{ca}	s2	d2	a1
0 325 11	D _{ca}	s2	d2	a1
0 325 12	D _{ca}	s2	d2	a1
0 325 13	Not applicable	-	-	-
0 325 14	D _{ca}	s2	d2	a1
0 325 15	Not applicable	-	-	-
0 325 23	Not applicable	-	-	-
0 325 24	Not applicable	-	-	-
0 325 25	Not applicable	-	-	-
0 325 26	C _{ca}	s1a	d1	a1
0 325 37	D _{ca}	s2	d2	a1
0 325 38	D _{ca}	s2	d2	a1
0 325 39	D _{ca}	s2	d2	a1
0 325 40	Not applicable	-	-	-
0 325 41	Not applicable	-	-	-
0 325 42	Not applicable	-	-	-
0 325 43	D _{ca}	s2	d2	a1
0 325 44	D _{ca}	s2	d2	a1
0 325 45	D _{ca}	s2	d2	a1
0 325 46	Not applicable	-	-	-
0 325 47	Not applicable	-	-	-
0 325 48	Not applicable	-	-	-
0 325 49	C _{ca}	s1a	d1	a1
0 325 50	D _{ca}	s2	d2	a1
0 325 51	D _{ca}	s2	d2	a1
0 325 52	D _{ca}	s2	d2	a1
0 325 53	D _{ca}	s2	d2	a1
0 326 65	D _{ca}	s2	d2	a1
0 326 66	D _{ca}	s2	d2	a1
0 326 67	D _{ca}	s2	d2	a1
0 326 68	D _{ca}	s2	d2	a1

	Euroclass	Classification criteria	Additional criteria	AV CP system
Non-combustible (for example mineral-insulated)	A _{ca}	EN ISO 1716 Gross combustion heat	-	"1+" including: - initial type test and continuous monitoring - audit and sampling test by a third-party certification body Manufacturer's factory production controls
Cables with low fire risk (different levels)	B1 _{ca}	EN 50399 Heat release Flame spread EN 60332-1-2 Flame propagation	Smoke production (s1a, s1b, s2, s3) EN50399/ EN61034-2 Acidity (a1, a2, a3) EN 50267-2-3 Flaming droplets (d0, d1, d2) EN 50399	"3+" including: - initial type test by a third-party laboratory Manufacturer's factory production controls
	B2 _{ca}			
	D _{ca}			
Standard cables	E _{ca}	EN 60332-1-2 Flame propagation	-	Manufacturer's factory production controls
No determined performance	F _{ca}	EN 60332-1-2 Flame propagation	-	"4": initial type test and manufacturer's factory production controls

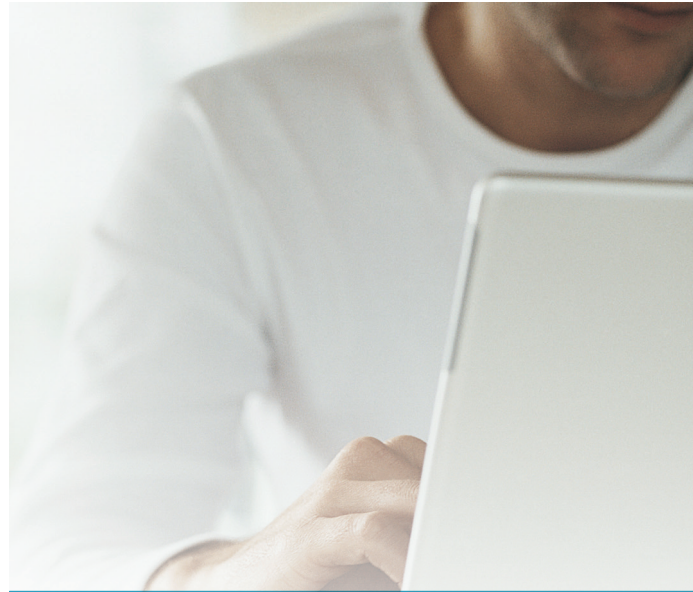

FOLLOW US TOO ON

@ website: www.legrand.eg

f legrand

legrandegypt



EMB Electrical Industries S.A.E.

Headquarter office

Pyramids Heights Office Park
KM 22 Cairo - Alex. desert road
Building 1B, 12556
Tel.: +202 3536 0000
Fax: +202 3536 0001
www.legrand.eg