

BRINGS VALUE IN  
QUALITY, TECHNOLOGY  
AND ABOVE ALL  
ITALIAN DESIGN



**2022**

Commercial & Residential **Solutions**

**Product** Catalogue



## بتشينو في مصر

بتشينو شركة إيطالية رائدة في صناعة المنتجات الكهربائية و الرقمية في العالم . وهي إحدى الشركات التابعة لمجموعة ليجراند الفرنسية المتواجدة في أكثر من ٨٠ دولة حول العالم . وقد تم إنشاء مصنع بتشينو مصر «EMB» عام ١٩٨٦ في مدينة السادات ، يعمل به أكثر من ٥٠٠ عامل ومهندس بأستخدام أحدث الآليات التكنولوجية و إختبارات الجودة العالمية ، وذلك لتقديم منتجات علي أعلي مستوي من الجودة والامان .

وقد تم إنضمام إي إم بي للصناعات الكهربائية ش.م.م. لمبادرة" بكل فخر صنع في مصر". تعمل المبادرة تحت إشراف مركز تحديث الصناعة (IMC) و وزارة التجارة والصناعة. وتهدف إلى دعم المنتجات المحلية والاقتصاد الوطني عن طريق تمكين المنتجات المصرية بجودتها العالية و تشجيع المصريين على شراء منتجات محلية عالية الجودة.

### SAFETY FIRST



Your safety is our main concern . We protect You and your family every day from electric hazards.

### UNIVERSAL SOLUTION



More than 300 functionalities to cover all your lighting , safety , date Communicathion energy saving needs.

### COMFORT & PEACE OF MIND



Sophisticated yet easy to use devices such as sensors and dimmers , will allow you to take complete control over your home , making your life easier than ever.

PROUD TO BE THE  
TRUSTED WORLD-WIDE BRAND  
FOR MANUFACTURING HIGH QUALITY  
PRODUCTS WITH THE FINEST DESIGN .

# PRODUCTS

CLASSIA	04
MATIX EDGE	13
SOLIDA	23
FORMA MAX	30
MAGIC	38
MCB	40
SAFETY BREAKER	44
FUSE SWITCH	46
COMPLIMENTARY PRODUCTS	48

# MATIX EDGE INNOVATIVE

DESIGN, COLOURS,  
AND FUNCTIONS

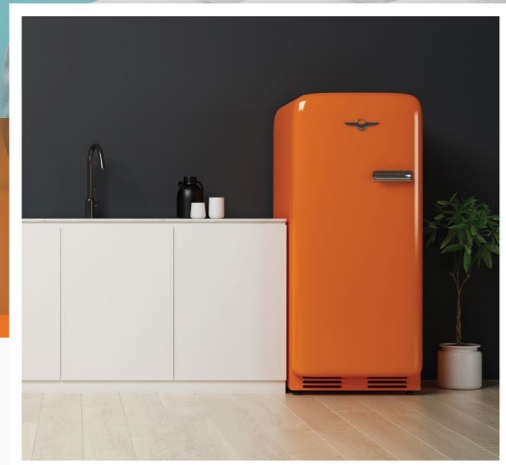

## MATIX EDGE

**BEYOND  
THE EDGE OF  
EXPECTATIONS**

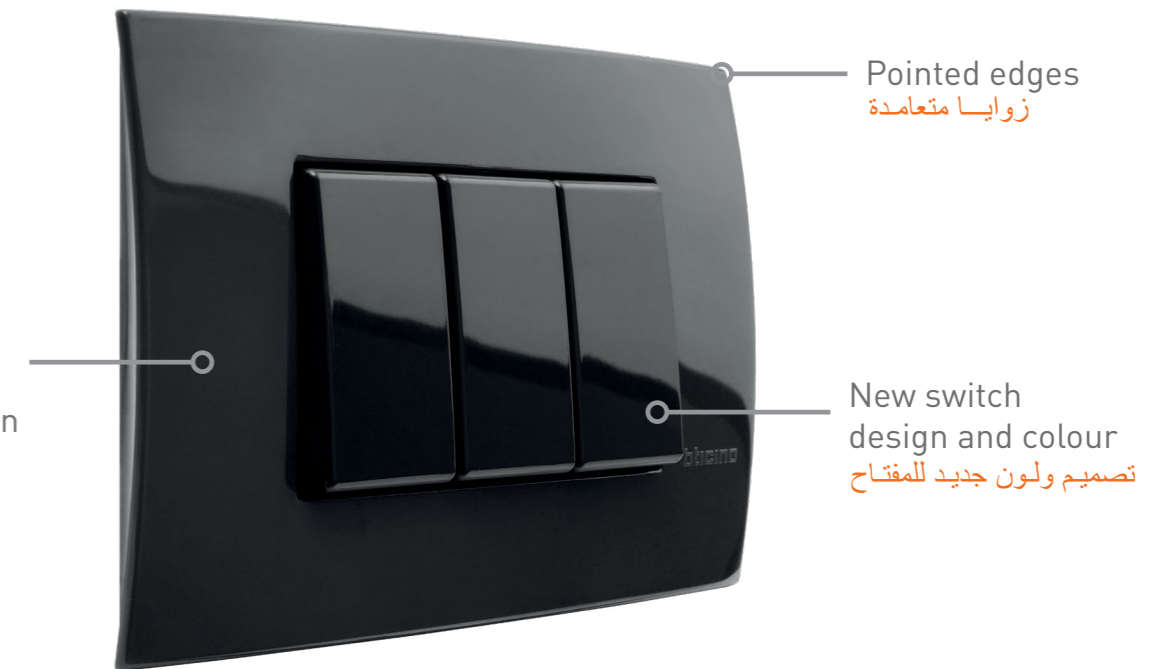

Pointed edges  
زوايا متعامدة

New thinner,  
curvy, & colorful  
cover plate design  
تصميم جديد للوجه

New switch  
design and colour  
تصميم ولون جديد للمفتاح

### COVER PLATE DESIGN

Pure lines flowing into a slightly curved surface convey all the typical lightness of contemporary design by BTicino. The harmony of the subtle but curved profile produces a particularly outstanding effect. The result is a rational design, essential and clean where every detail expresses quality.





# NEW DESIGN AND COLOUR OF THE SWITCHES

25 colours of cover plates,  
split into 3 families:

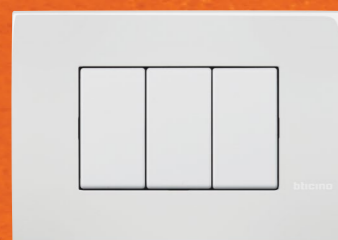

**NEUTRAL**  
Perfect colour match between  
cover plate and control.



**METALS**  
Metal finishes for a light point  
with a bright and glossy look.

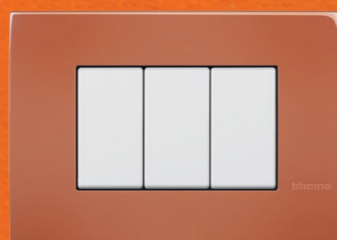

**COLOURS**  
Strong and bright colours,  
suitable for environments with character.

BASIC CONTROL DEVICES

مفاتيح التحكم الاساسيه



ITEM	ONE-WAY SWITCHES
<input type="checkbox"/> AM5001E <input type="checkbox"/> A5001E <input type="checkbox"/> AG5001E	1P 16 AX - 250 Va.c.
<input type="checkbox"/> AM5001LE <input type="checkbox"/> A5001LE <input type="checkbox"/> AG5001LE	1P 16 AX - 250 Va.c. - Optional add on lightable with led lamp LN4742V230 - LN4742V230V - device with backlight clearly visible even in daylight and in well-it
<input type="checkbox"/> AM5001/2E <input type="checkbox"/> A5001/2E <input type="checkbox"/> AG5001/2E	1P 16 AX - 250 Va.c. - 2 modules
<input type="checkbox"/> AM5011E <input type="checkbox"/> A5011E <input type="checkbox"/> AG5011E	2P 16 AX - 250 Va.c.
<input type="checkbox"/> AM5011/32 <input type="checkbox"/> A5011/32 <input type="checkbox"/> AG5011/32	2P 32 A - 250 Va.c.
ITEM	INTERMEDIATE SWITCHES - CHANGEOVER SWITCHES
<input type="checkbox"/> AM5012E <input type="checkbox"/> A5012E <input type="checkbox"/> AG5012E	intermediate switch 16 AX - 250 Va.c.
<input type="checkbox"/> AM5086 <input type="checkbox"/> A5086 <input type="checkbox"/> AG5086	selector switch - rotary changeover switch 1P 3 A - 250 Va.c. - 1 way - 4 positions to control air conditioners, fans, etc.

ITEM	TWO-WAY SWITCHES
<input type="checkbox"/> AM5003E <input type="checkbox"/> A5003E <input type="checkbox"/> AG5003E	1P 16 AX - 250 Va.c.
<input type="checkbox"/> AM5003/2E <input type="checkbox"/> A5003/2E <input type="checkbox"/> AG5003/2E	1P 16 AX - 250 Va.c. - Optional add on lightable with led lamp LN4742V230 - LN4742V230V - device with backlight clearly visible even in daylight and in well-it
<input type="checkbox"/> AM5003/2E <input type="checkbox"/> A5003/2E <input type="checkbox"/> AG5003/2E	1P 16 AX - 250Va.c. - 2 modules
ITEM	PUSHBUTTONS
<input type="checkbox"/> AM5005E <input type="checkbox"/> A5005E <input type="checkbox"/> AG5005E	1P (NO) 10 A - 250 Va.c.
<input type="checkbox"/> AM5005LE <input type="checkbox"/> A5005LE <input type="checkbox"/> AG5005E	1P (NO) 10 A - 250 Va.c. - Optional add on lightable with led lamp LN4742V230 - LN4742V230V - device with backlight clearly visible even in daylight and in well-it
<input type="checkbox"/> AM5005LBE <input type="checkbox"/> A5005LBE <input type="checkbox"/> AG5005LBE	1P (NO) 10 A - 250 Va.c. "bell symbol" - Optional add on lightable Lamp to be added LN4742V230 - LN4742V230V
<input type="checkbox"/> AM5005LLE <input type="checkbox"/> A5005LLE <input type="checkbox"/> AG5005LLE	1P (NO) 10 A - 250 Va.c. "lamp symbol" - Optional add on lightable Lamp to be added LN4742V230 - LN4742V230V
<input type="checkbox"/> AM5037 <input type="checkbox"/> A5037 <input type="checkbox"/> AG5037	double 1P (NO) + 1P (NO) 10A - 250Va.c. interlocked

**SOCKETS**  
مخارج كهرباء

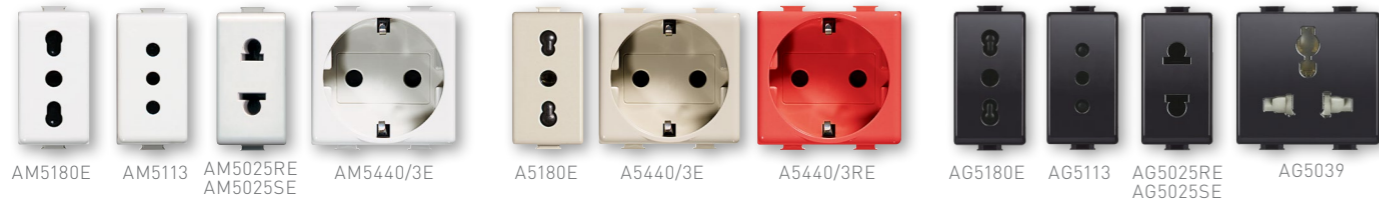

ITEM	ITALIAN STANDARD SOCKETS
<input type="checkbox"/> AM5180E <input type="checkbox"/> A5180E <input type="checkbox"/> AG5180E <input type="checkbox"/> A5180RE	socket 2P+E 10A and 16 A 250 Va.c. - centre distance 19 mm and 26 mm shielded holes

<input type="checkbox"/> AM5113E <input type="checkbox"/> A5113E <input type="checkbox"/> AG5113E	socket 2P+E 10 A 250 Va.c. - centre distance 19 mm shielded holes Ø 4 mm
---	--

ITEM	EURO-AMERICAN STANDARD SOCKETS
<input type="checkbox"/> AM5025RE <input type="checkbox"/> A5025RE <input type="checkbox"/> AG5025RE	socket 2P 16 A 127/250 Va.c. - shielded holes

<input type="checkbox"/> AM5025SE <input type="checkbox"/> A5025SE <input type="checkbox"/> AG5025SE	socket 2P 16 A 127/250 Va.c. - unshielded holes
--	---

ITEM	MULTISTANDRD SOCKET
<input type="checkbox"/> AM5039 <input type="checkbox"/> A5039 <input type="checkbox"/> AG5039	socket 2P+E 5/6/10/13 A 250 Va.c. and 127 Va.c. multistandard - 5 A and 13 A = BS std., 6 A = Indian std., 10 A = European std.

ITEM	GERMAN STANDARD SOCKETS
<input type="checkbox"/> AM5440/3E <input type="checkbox"/> A5440/3E <input type="checkbox"/> AG5440/3E <input type="checkbox"/> A5440/30E <input type="checkbox"/> A5440/3RE	socket 2P+E 10/16A 250V - type earth side contacts - shielded socket contacts

**TV, TELEPHONE, DATA SOCKETS**  
مخارج تليفزيون، تليفون و انترنت



ITEM	TV JACKS
<input type="checkbox"/> AM5202D <input type="checkbox"/> A5202D <input type="checkbox"/> AG5202D	Star coaxial socket for single-user aerial systems, also remote powered and centralised, and singleuser / centralised satellite systems with current and signal transfer for channels selection; shielded connection clamps with captive screws - Ø 9.5 mm; male connector - 1 module

<input type="checkbox"/> AM5173DFE <input type="checkbox"/> A5173DFE <input type="checkbox"/> AG5173DFE	type F TV coax connector - impedance 75Ω - screw coupling
---	---

<input type="checkbox"/> AM5210M2D <input type="checkbox"/> A5210M2D <input type="checkbox"/> AG5210M2D	Star demixed coaxial socket for single-user aerial systems, also remote powered and shunting centralised, and for single-user/shunting centralised satellite systems with current and signal transfer for channels selection, and for radio systems; 0.9.5 mm male TV connector - type F SAT connector and female radio Ø 9.5 mm - 2 modules
---	--

ITEM	RJ11 CONNECTORS	type of connector	No. of pairs	No. of connection
<input type="checkbox"/> AM5958/11NE <input type="checkbox"/> A5958/11NE <input type="checkbox"/> AG5958/11NE	RJ11		2	K10

ITEM	RJ11 CONNECTORS	type of connector	cat.	No. of connection
<input type="checkbox"/> AM5979C5E <input type="checkbox"/> A5979C5E <input type="checkbox"/> AGE5979C5E	RJ45		5E UTP	Cutter(1)
<input type="checkbox"/> AM5979C6 <input type="checkbox"/> A5979C6 <input type="checkbox"/> AGE5979C6	RJ45		6 UTP	Cutter(1)

(1) TOOLLESS type

**AUDIO VIDEO CONNECTORS**  
مخارج الصوت والصورة

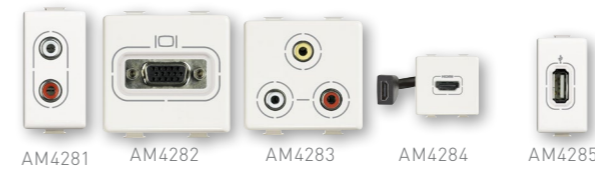

ITEM	AUDIO VIDEO CONNECTORS
<input type="checkbox"/> AM4281 <input type="checkbox"/> AM4281 <input type="checkbox"/> AG4281	connector - RCA x 2

<input type="checkbox"/> AM4282 <input type="checkbox"/> A4282 <input type="checkbox"/> AG4282	connector - HD15
--	------------------

<input type="checkbox"/> AM4283 <input type="checkbox"/> A4283 <input type="checkbox"/> AG4283	RCA x 3 connector
--	-------------------

<input type="checkbox"/> AM4284 <input type="checkbox"/> A4284 <input type="checkbox"/> AG4284	HDMI connector
--	----------------

<input type="checkbox"/> AM4285 <input type="checkbox"/> A4285 <input type="checkbox"/> AG4285	USB connector
--	---------------

ITEM	AUDIO POTENTIOMETER
<input type="checkbox"/> AM5305 <input type="checkbox"/> A5305 <input type="checkbox"/> AG5305	audio potentiometer 0-5W 47 Ohm

(\* ) ITEMS MANAGED ON DEMAND.  
TO ORDER CONSULT THE BTICINO SALES STAFF

**EMERGENCY LAMPS**  
مصابيح الطوارئ

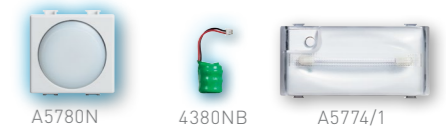

ITEM	REMOVABLE LED LAMP
<input type="checkbox"/> A5780N	It automatically turns on in case of power failure. Push&Pull extracting system - high efficiency white LED - ON/OFF switch and SPOT button to increase light intensity if needed - interchangeable Ni-MH batteries with 2h duration - low consumption in stand-by 0,4W - 127/230V power supply. Recharging base, 2 modules.
<input type="checkbox"/> 4380NB	spare battery for rechargeable torch art. A5780N
<input type="checkbox"/> A5774/1	emergenCY LAMPS

**DIMMERS**  
ديمرات



ITEM	DIMMER
<input type="checkbox"/> AM5702 <input type="checkbox"/> A5702 <input type="checkbox"/> AG5702	rotary dimmer - built-in two way switch - MOSFET tech. - built-in fuse 60-500 W 230 Va.c.
<input type="checkbox"/> AM5706 <input type="checkbox"/> A5706 <input type="checkbox"/> AG5706	rotary dimmer 100 - 500 W 230 Va.c.

NOTE: to choose the dimmer according to the technical features, see the table below

ITEM	UNIVERSAL DIMMER
<input type="checkbox"/> AM5713 <input type="checkbox"/> A5713 <input type="checkbox"/> AG5713	universal dimmer (resistive - inductive, capacitive, fluorescent compact and dimmer LEDs) - 150/200/400 W with electronic protection - 2 modules

NOTE: to choose the dimmer according to the technical features, see the table below

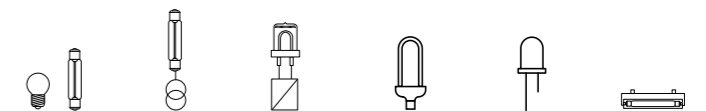

Loads managed									
Item	Type	Range	supply std	Incandescents and halogens	Halogens with ferromagnetic transformer	Halogens with electronic transformer	Dimmerable compact fluorescents	Dimmerable lead lamps	F luorescents with electronic 0-10 V ballast
AM5702 A5702 AG5702	Resistive	230 50	230 Va.c.	60 ÷ 500 W					
AM5706 A5706 AG5706	Resistive	230 50 ÷ 60	230 Va.c.	100 ÷ 500 W					
AM5713 A5713 AG5713	Universal	100 ÷ 240 50 ÷ 60	240 Va.c. 100 Va.c.	3 ÷ 200 W 3 ÷ 400 W	3 ÷ 200 VA 3 ÷ 400 VA	3 ÷ 200 VA 3 ÷ 400 VA	3 ÷ 75 W 3 ÷ 150 W	3 ÷ 75 W 3 ÷ 150 W	

**SPECIAL SOCKETS**  
مخارج للإستخدامات الخاصة



ITEM	USB CHARGER
<input type="checkbox"/> AM5285C1 <input checked="" type="checkbox"/> A5285C1 <input checked="" type="checkbox"/> AG5285C1	USB connector 5 Vdc USB charger to be used only for recharging electronic devices up to 1100 mA like mobile phones, smartphones, tablets and similar - 230 Va.c. power supply
<input type="checkbox"/> AM5285C2 <input checked="" type="checkbox"/> A5285C2 <input checked="" type="checkbox"/> AG5285C2	USB connector 5 Vdc USB charger for quick charge of one single electronic device (mobile phones, smartphones, tablets or similar) up to 2400 mA or simultaneous charging of two devices up to 1200 mA - 110=230 Vac 50=60 Hz power supply

ITEM	PASSIVE INFRARED SWITCHES
<input type="checkbox"/> AM5751 <input checked="" type="checkbox"/> A5751 <input checked="" type="checkbox"/> AG5751	switch with passive infrared ray movement sensor - variable threshold twilight circuit with possibility of exclusion - timing circuit to delay switching off which can be adjusted from 30 seconds to 10 minutes - out put relay 2 A resistive/ inductive - 230 Va.c. power supply - 50 and 60 Hz

ITEM	BLANKING MODULES AND OUTPUTS
<input type="checkbox"/> AM5000E <input checked="" type="checkbox"/> A5000E <input checked="" type="checkbox"/> AG5000E	blanking module key

**LED**  
لمبات



ITEM	LEDS FOR CONTROLS AND LIGHTS
<input type="checkbox"/> LN4742V230	LED for rocker controls 230 V - amber
<input type="checkbox"/> LN4742V230V	LED for rocker controls 230 V - green

NOTE: 127V and 12/24V are also available.

**AUDIBLE & OPTICAL SIGNALLING**  
الأجراس ولمبات البيان



ITEM	STEP MARKER LAMP
<input type="checkbox"/> AM5041 <input checked="" type="checkbox"/> A5041N <input checked="" type="checkbox"/> AG5041	bronze bell 230 Va.c. - 11 VA - 80 dB
<input type="checkbox"/> AM5048 <input checked="" type="checkbox"/> A5048N <input checked="" type="checkbox"/> AG5048N	buzzer 230 Va.c. - 10VA - 75 dB

ITEM	BUZZERS AND BELLS
<input type="checkbox"/> A5630/230	bronze bell 230 Va.c. - 11 VA - 80 dB
<input type="checkbox"/> A5631/230	buzzer 230 Va.c. - 10VA - 75 dB

ITEM	LAMP-HOLDER
<input type="checkbox"/> AM5062B <input checked="" type="checkbox"/> A5062B <input checked="" type="checkbox"/> AG5062B	double lamp-holder with 2 diffusers: 1 orange + 1 clear - for lamps item LN4742V230 - LN4742V230V
<input type="checkbox"/> AM5064V <input checked="" type="checkbox"/> A5064V <input checked="" type="checkbox"/> AG5064V	double lamp-holder with 2 diffusers: 1 red + 1 green - for lamps item LN4742V230 - LN4742V230V

<input type="checkbox"/> AM5060A <input checked="" type="checkbox"/> A5060A <input checked="" type="checkbox"/> AG5060A	lamp-holder with orange diffuser - for lamps item LN4742V230 - LN4742V230V
<input type="checkbox"/> AM5060R <input checked="" type="checkbox"/> A5060R <input checked="" type="checkbox"/> AG5060R	lamp-holder with red diffuser - for lamps item LN4742V230 - LN4742V230V

<input type="checkbox"/> AM5060B <input checked="" type="checkbox"/> A5060B <input checked="" type="checkbox"/> AG5060B	lamp-holder with clear diffuser - for lamps item LN4742V230 - LN4742V230V
---	---

<input type="checkbox"/> AM5060V <input checked="" type="checkbox"/> A5060V <input checked="" type="checkbox"/> AG5060V	lamp-holder with green diffuser - for lamps item LN4742V230 - LN4742V230V
---	---

# MATIX EDGE - SUPPORT FRAMES

SUPPORT FRAMES

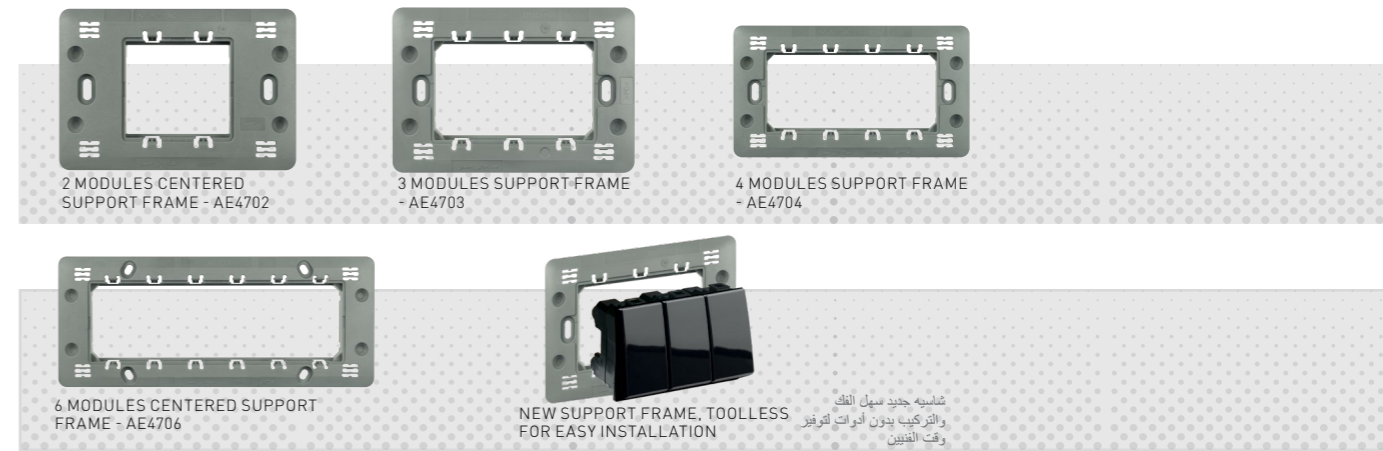

**MATIX EDGE - 3 MODULE INSTALLATION SYSTEM**  
COVER PLATE INSTALLATION

BOXES	SUPPORTS	NO. OF MODULES	MATIX EDGE COVER PLATES
503EG (106X71X52 MM)	AE4703 WITH SCREWS	3 MODULES	AE4803M3...

**IDROBOX - IP55 WATERPROOF**  
غطاء حماية ضد الماء



ITEM	IDROBOX - IP55 WATERPROOF COVER
<input type="checkbox"/> 25602B <input checked="" type="checkbox"/> 25602	2 module MATIX IDROBOX - Installation on 502E flush mounting box 2 modules grey RAL7035
<input type="checkbox"/> 25603B <input checked="" type="checkbox"/> 25603	3 module MATIX IDROBOX - Installation on 503E flush-mounting box 3 modules grey RAL7035
<input type="checkbox"/> 25604B <input checked="" type="checkbox"/> 25604	4 module MATIX IDROBOX - Installation on 504E flush-mounting box 4 modules grey RAL7035

COVER PLATES:  
TABLE FOR SELECTING CODE  
إختيار أوجه الماتكس إيدج

MODULES						
	1	2 CENTRED	3	4	6	
<b>NATURALS</b>						
	WHITE	AE4803M1BN	AE4803M2BN	AE4803M3BN	AE4804BN	AE4806BN
	IVORY	AE4803M1AV	AE4803M2AV	AE4803M3AV	AE4804AV	AE4806AV
	GREY			AE4803M3GR	AE4804GR	AE4806GR
<b>COLORS</b>						
	BEIGE			AE4803M3BG	AE4804BG	AE4806BG
	BLACK			AE4803M3BK	AE4804BK	AE4806BK
	BROWN			AE4803M3BR	AE4804BR	AE4806BR
	PINK			AE4803M3PN	AE4804PN	AE4806PN
	LIGHT PURPLE			AE4803M3LP	AE4804LP	AE4806LP
	PURPLE			AE4803M3PR	AE4804PR	AE4806PR
	LEMON			AE4803M3LM	AE4804LM	AE4806LM
	AMBER			AE4803M3AM	AE4804AM	AE4806AM
	RED			AE4803M3RD	AE4804RD	AE4806RD
	TURQUOISE			AE4803M3TR	AE4804TR	AE4806TR
	BLUE			AE4803M3BL	AE4804BL	AE4806BL
	DARK BLUE			AE4803M3DB	AE4804DB	AE4806DB
	GREEN TEA			AE4803M3GT	AE4804GT	AE4806GT
	GREEN			AE4803M3GN	AE4804GN	AE4806GN
<b>METALS</b>						
	MATT GOLD			AE4803M3MGL	AE4804MGL	AE4806MGL
	SILVER			AE4803M3MSL	AE4804MSL	AE4806MSL
	IRON			AE4803M3MIR	AE4804MIR	AE4806MIR
	STAINLESS			AE4803M3MST	AE4804MST	AE4806MST
	PEARL			AE4803M3MPL	AE4804MPL	AE4806MPL
	TITANIUM			AE4803M3MTA	AE4804MTA	AE4806MTA
	COPPER			AE4803M3MCO	AE4804MCO	AE4806MCO
	BRONZE			AE4803M3MBZ	AE4804MBZ	AE4806MBZ
<b>SUPPORTS</b>						
FIXING WITH SCREWS	AE4703	AE4702	AE4703	AE4704	AE4706	

MATIX EDGE - 3 MODULE COVER PLATE COLOURS

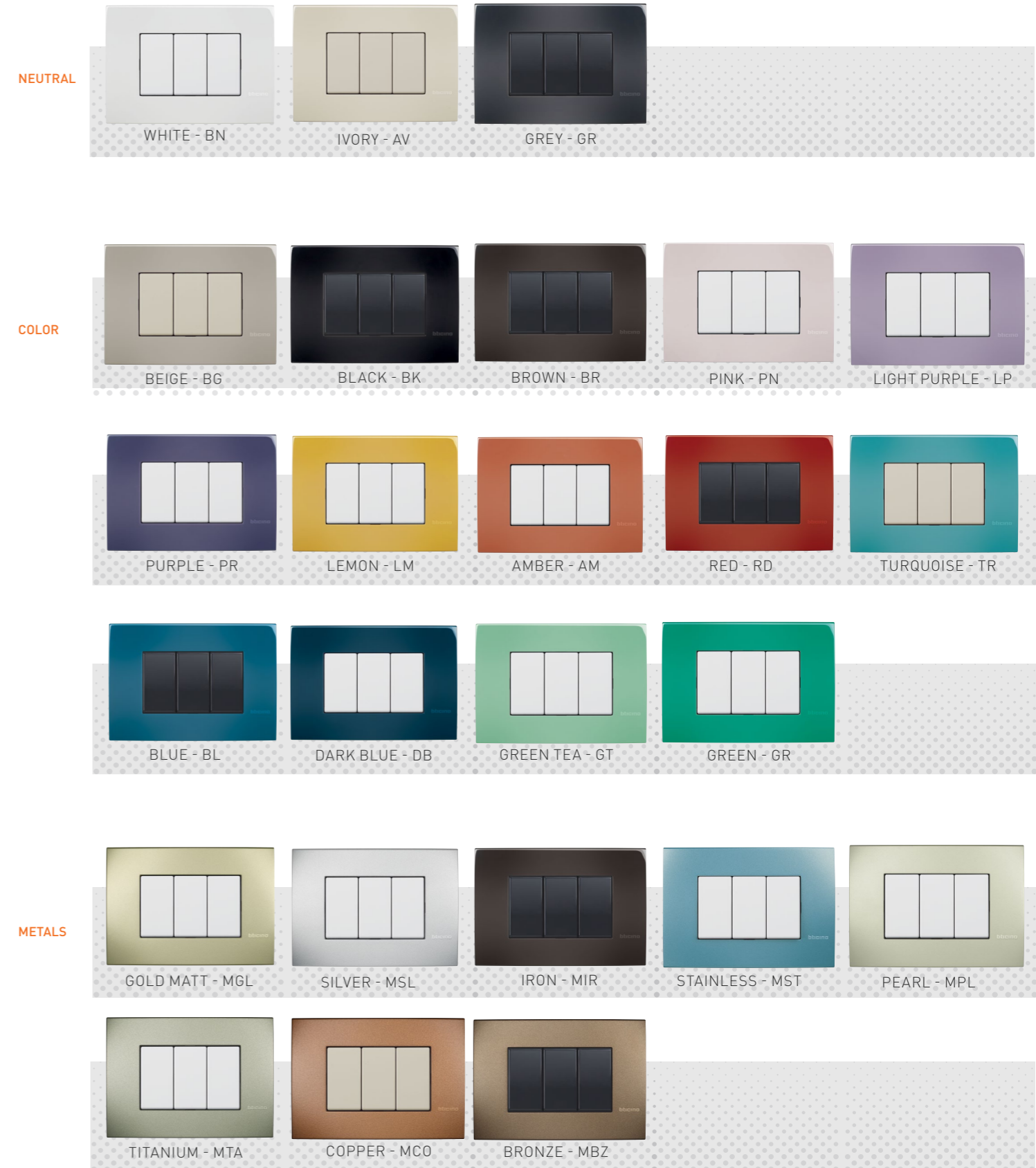



SOLIDA

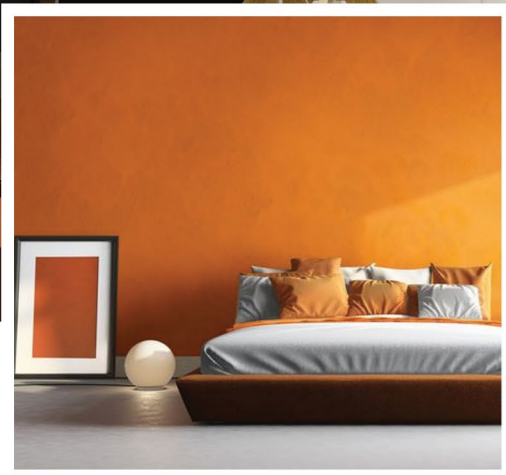

COMBINATION  
OF QUALITY & VALUE



SOLIDA

# IDEAL FOR RESIDENTIAL & SMALL BUSINESS APPLICATIONS

HOUSES, FLATS, SMALL OFFICES, SMALL SHOPS



## THE RANGE WIDENS WITH NEW FINISHES

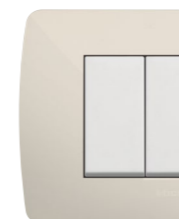

New finishings: **neutrals**  
Example **IVORY**  
White, Ivory

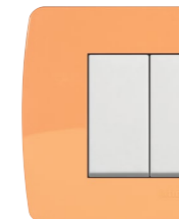

New finishings: **colors**  
Example **LIGHT AMBER**  
Blue, Black, Pine, Pink, Light amber,  
Light yellow, Bright red



New finishings: **metal effect**  
Example **TITANIUM**  
Titanium, Light brown, Red,  
Dark brown, Blue violet, Silver, Matt gold

**AESTHETIC FEATURES:**  
mechanism with white or ivory gloss  
finish, and illuminated switches.  
Cover plates with smooth shapes.

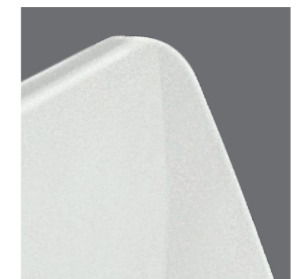



# EASY TO INSTALL AND WIRE

آمن و سهل التوصيل

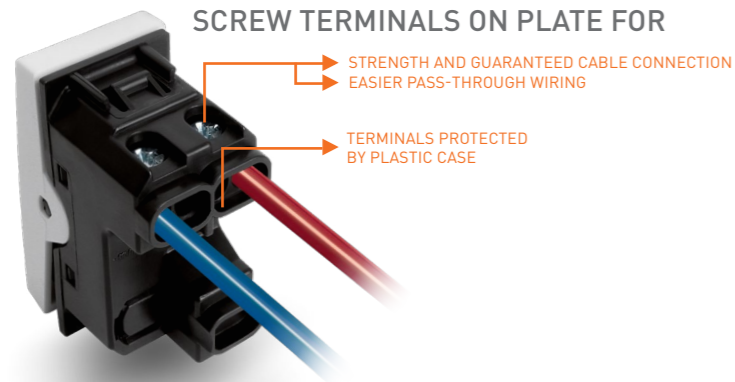

SCREW TERMINALS ON PLATE FOR

STRENGTH AND GUARANTEED CABLE CONNECTION  
EASIER PASS-THROUGH WIRING

TERMINALS PROTECTED  
BY PLASTIC CASE

# CHILDPROOF

آمن للأطفال

German and Italian standard socket outlets, all with safety shutters designed to protect children



## CONTROL DEVICES

مفاتيح التحكم الأساسية



ITEM	CONTROL DEVICES
<input type="checkbox"/> D4001L <input checked="" type="checkbox"/> DA4001L	One-way switch 1P 16 AX 250 Va.c.
<input type="checkbox"/> D4003L <input checked="" type="checkbox"/> DA4003L	Two-way switch 1P 16 AX 250 Va.c.
<input type="checkbox"/> D4005L <input checked="" type="checkbox"/> DA005L	Pushbutton 1P (NO) 10 A 250 Va.c. with bell symbol
<input type="checkbox"/> D4005LN <input checked="" type="checkbox"/> DA4005LN	Pushbutton 1P (NO) 10 A 250 Va.c.

ITEM	CONTROL DEVICES
<input type="checkbox"/> D4004L <input checked="" type="checkbox"/> DA4004L	Four-way switch 16A 250Va.c.
<input type="checkbox"/> D4027 <input checked="" type="checkbox"/> DA4027	1 P 1-0-2 double-key changeover switch 16 A 250 Va.c.
<input type="checkbox"/> D4402 <input checked="" type="checkbox"/> DA4402	Rotary dimmer - built-in two way switch -MOS-FET tech. - built-in fuse 60-500 W 230 Va.c.
<input type="checkbox"/> D4403 <input checked="" type="checkbox"/> DA4403	Resistive dimmer for incandescent and halogen lamps. 100-500W 230 Va.c.

## SOCKETS

مخارج كهرباء



ITEM	SOCKET OUTLETS
<input type="checkbox"/> D4125 <input checked="" type="checkbox"/> DA4125	Euro-american standard socket 2P 16 A 127/250 Va.c. - Ø 5 mm
<input type="checkbox"/> D4140 <input checked="" type="checkbox"/> DA4140	German standard socket 2P+E 16 A 127/250 Va.c. P31 type - with shutters for child protection
<input type="checkbox"/> D4180 <input checked="" type="checkbox"/> DA4180	Italian standard socket 2P+E 16 A 250 Va.c. - centre distance 19 mm and 26 mm - for plugs 2P and 2P+E 10 and 16 A - with shutters for child protection

ITEM	SOCKET OUTLETS
<input type="checkbox"/> D4122ET <input checked="" type="checkbox"/> DA4122ET	Egyptian standard socket 2P 10 A 250 Va.c.- contact tubes Ø 4 - 4.8 mm - centre line of holes 19 mm
<input type="checkbox"/> D5285C1 <input checked="" type="checkbox"/> DA5285C1	5 Vd.c. USB charger to be used only for recharging electronic devices up to 1100 mA like mobile phones, smartphones, tablets and similar - 230 Va.c. power supply

## ACCESSORIES

الإكسسوارات



ITEM	ACCESSORIES
<input type="checkbox"/> D4950S <input checked="" type="checkbox"/> DA4950S	1-module blanking plate
<input type="radio"/> LN4742V230	LED for control devices 230 V - amber

## BELLS

الأجراس



ITEM	BELLS
<input type="checkbox"/> D4351/230 <input checked="" type="checkbox"/> DA4351/230	Bronze Bell - 230Vac - 11 VA - 80 dB

## TV, RJ11, RJ45 SOCKETS

مخارج تليفزيون، تليفون وإنترنت



CAT. NO.	TV, RJ11, RJ45 SOCKET
<input type="checkbox"/> D4202D <input checked="" type="checkbox"/> DA4202D	Shunted coaxial jack - Ø 9.5 mm - male jack - screened TV + SAT sockets in die cast housing with current flow
<input type="checkbox"/> D4269F <input checked="" type="checkbox"/> DA4269F	Type F TV female connector - 75 Ω impedance - screw coupling - 1 module
<input type="checkbox"/> D4232RJ11 <input checked="" type="checkbox"/> DA4232RJ11	RJ 11 telephone sockets

<input type="checkbox"/> D4262C5E <input checked="" type="checkbox"/> DA4262C5E	RJ 45 data transmission/ telephone sockets - 110IDC cat5E UTP
<input type="checkbox"/> D5979C6 <input checked="" type="checkbox"/> DA5979C6	RJ45 Cat. 6 - UTP - Type of connection: TOOLLESS











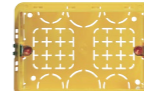
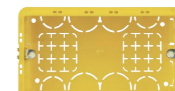



COVER PLATES: COLOURS RANGE



EASY AND SECURE INSTALLATION

آمن و سهل التركيب

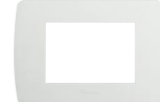
TABLE OF CHOICE

<b>BOXES</b>	 503EG	 504E	 506L		
<b>FRAMES</b>	 D4703	 D4704	 D4706		
<b>N° OF MODULES</b>	 1 MODULE	 2 MODULES	 3 MODULES	 4 MODULES	 6 MODULES
<b>PLATES</b>	 D4803M1...	 D4803M2...	 D4803M3...	 D4804...	 D4806...

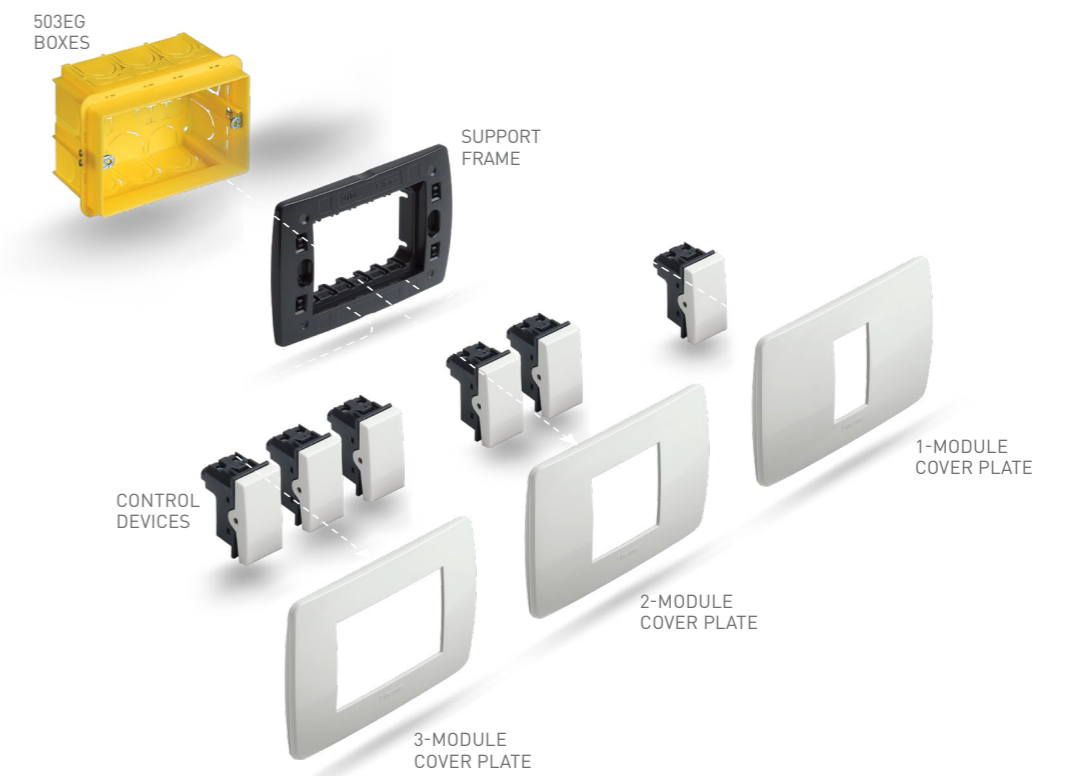

## TABLE FOR SELECTING CODE

إختيار أوجه السوليدا

MODULES	1	2	3	4	6
	■	■ ■	■ ■ ■	■ ■ ■ ■	■ ■ ■ ■ ■ ■

NATURALS						
■	WHITE	D4803M1BN	D4803M2BN	D4803M3BN	D4804BN	D4806BN
■	IVORY	D4803M1AV	D4803M2AV	D4803M3AV	D4804AV	D4806AV

COLORS						
■	BLUE	D4803M1BE	D4803M2BE	D4803M3BE	D4804BE	D4806BE
■	BLACK	D4803M1BK	D4803M2BK	D4803M3BK	D4804BK	D4806BK
■	PINE	D4803M1PI	D4803M2PI	D4803M3PI	D4804PI	D4806PI
■	PINK	D4803M1PK	D4803M2PK	D4803M3PK	D4804PK	D4806PK
■	LIGHT AMBER	D4803M1AB	D4803M2AB	D4803M3AB	D4804AB	D4806AB
■	LIGHT YELLOW	D4803M1LY	D4803M2LY	D4803M3LY	D4804LY	D4806LY
■	BRIGHT RED	D4803M1RE	D4803M2RE	D4803M3RE	D4804RE	D4806RE

METALS EFFECT						
■	TITANIUM	D4803M1TT	D4803M2TT	D4803M3TT	D4804TT	D4806TT
■	LIGHT BROWN	D4803M1LB	D4803M2LB	D4803M3LB	D4804LB	D4806LB
■	RED	D4803M1RD	D4803M2RD	D4803M3RD	D4804RD	D4806RD
■	DARK BROWN	D4803M1DB	D4803M2DB	D4803M3DB	D4804DB	D4806DB
■	BLUE VIOLET	D4803M1BV	D4803M2BV	D4803M3BV	D4804BV	D4806BV
■	SILVER	D4803M1SL	D4803M2SL	D4803M3SL	D4804SL	D4806SL
■	MATT GOLD	D4803M1GL	D4803M2GL	D4803M3GL	D4804GL	D4806GL

FRAME  
الشاسيه

D4703

D4703

D4703

D4704

D4706

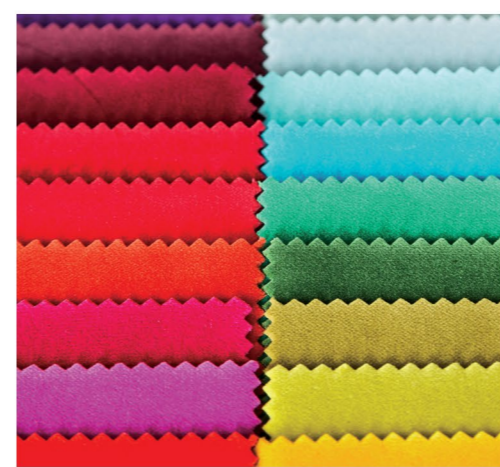

FORMA MAX

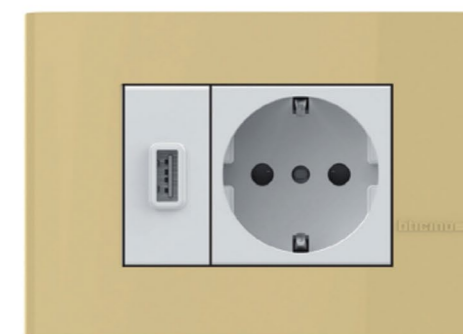
JUST WHAT  
YOU NEED

FORMA MAX

# NEW DESIGN

The Italian style, quality and originality guarantee by BTicino



The new plate is characterized by a very taut surface that connects on the sides with a nice curve; the curve is also highlighted by the brand completed by a satin line that links the plates to the wall. The plate is also decorated with a subtle effect obtained thanks to the up and down edges.



Slim effect

Squared shape with sophisticate curves on sides

Branded Detail

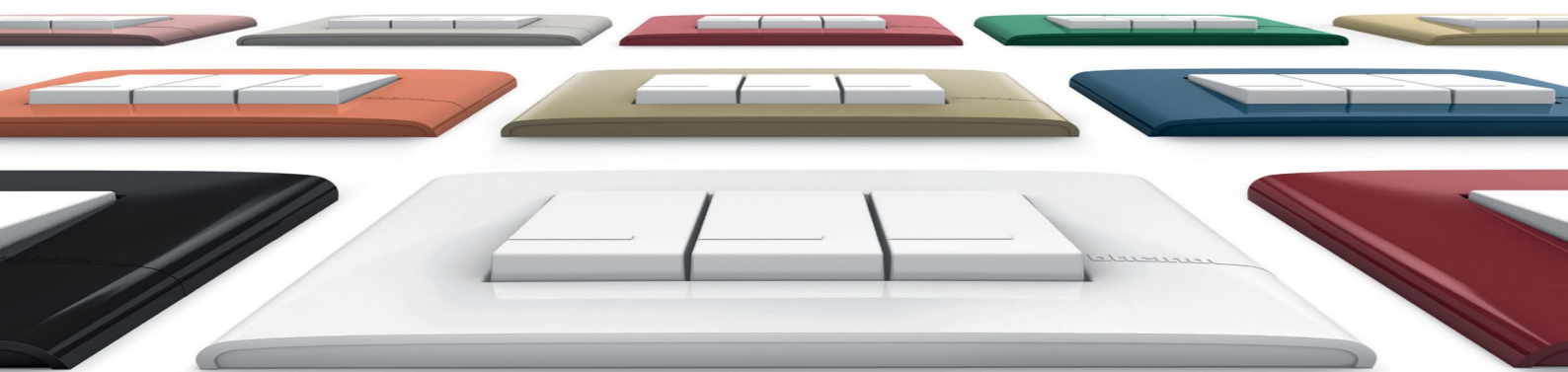

FORMA MAX

## NEW AND ESSENTIAL FINISHES

### TOTAL LOOK

White and ivory that you combine with the keys give total look effect

### COLORS

Blue, Black, Pine, Pink, Light amber, Light yellow, Bright red

### METALS

Titanium, Light brown, Red, Dark brown, Blue violet, Silver, Matt gold

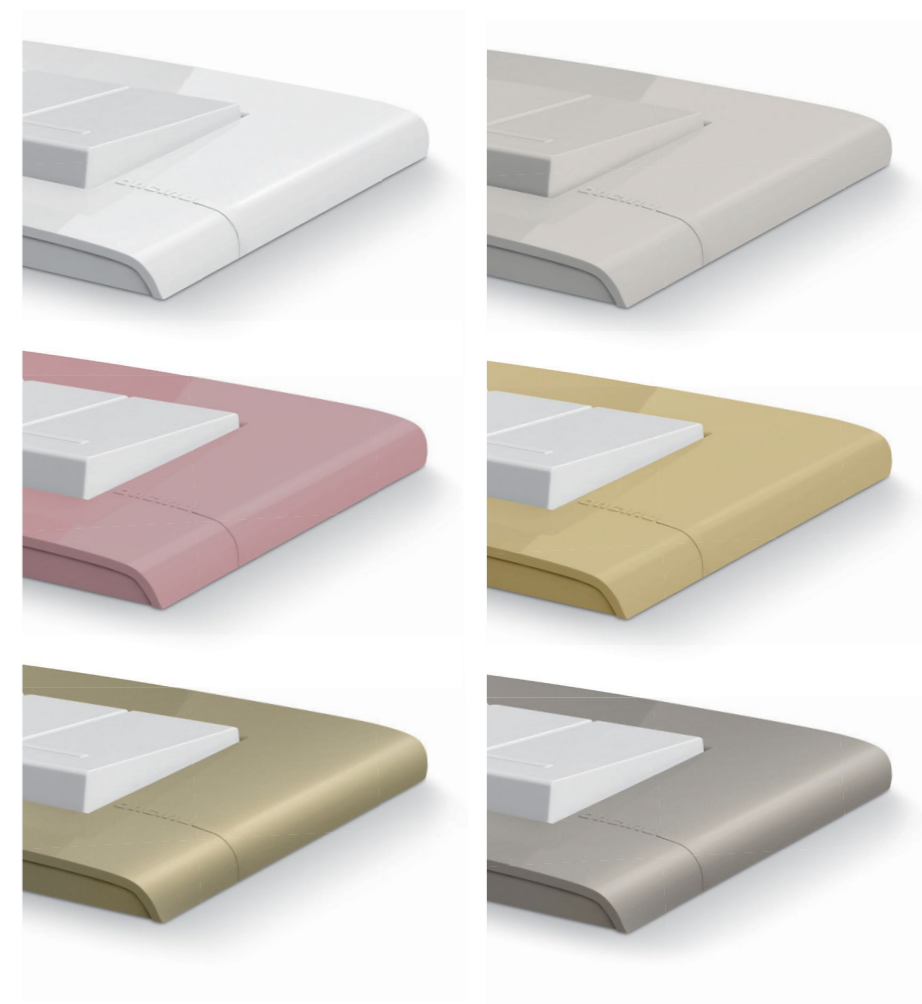

# EASY AND SECURE INSTALLATION

## INSTALLATION FROM THE FRONT

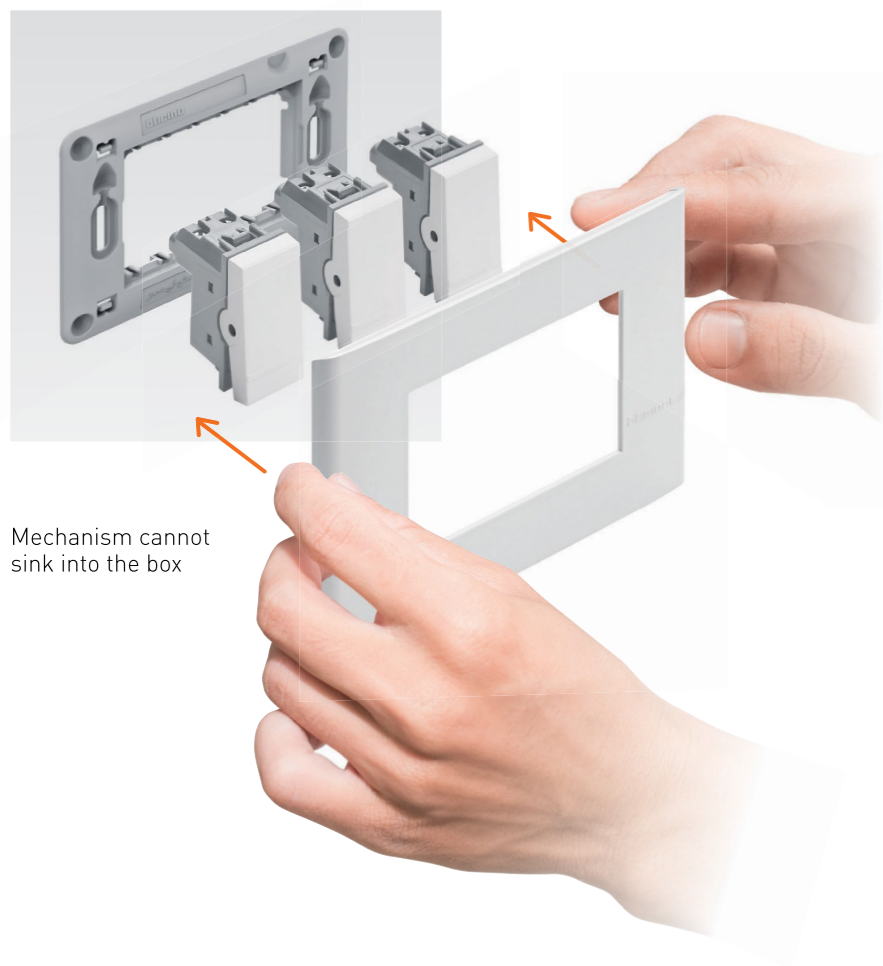

Mechanism cannot sink into the box

## EASY TO INSTALL AND WIRE

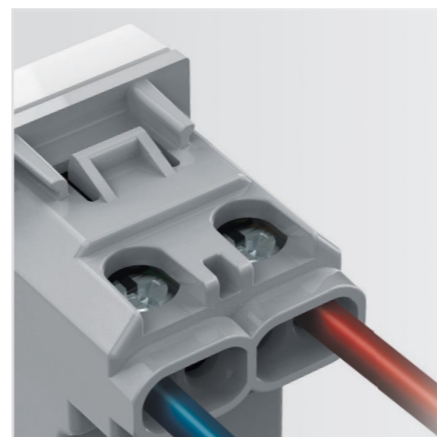

**SCREW TERMINALS ON PLATE FOR**

- Strength and guaranteed cable connection
- Easier pass-through wiring
- Terminals protected by plastic case



**PLATE**  
The plate screw terminals ensure durable connections

## NEW OFFER USB CHARGER



The USB chargers, suitable for smartphones, Mp3 players, navigators, tablets etc., guarantee a fast charge and greater power, adapting perfectly to the energy requirements of latest generation batteries.

**SUITABLE** for all rooms thanks to their small size. Recommended in the bedroom or kitchen.

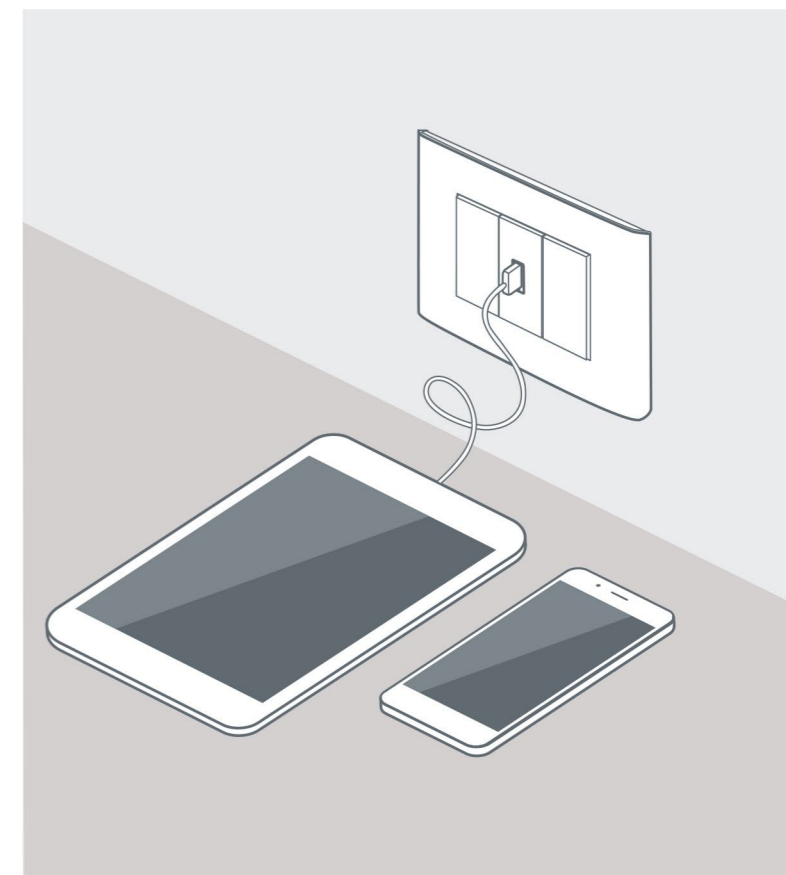

## The Forma Max range widens with more new functions



BE4004LW



Resistive dimmer  
BE4403W



BE4232RJ11W

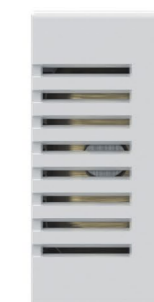

BE4351V230W

CONTROL DEVICES

مفاتيح التحكم الرئيسية



BE4001LW BE4003LW BE4004LW BE4403W BE4005LW

SOCKET OUTLETS

مخارج كهرباء



BE4122ETW BE4140W BE4180W BE5285C1W

ITEM	CONTROL DEVICES
<input type="checkbox"/> BE4001LW <input checked="" type="checkbox"/> BE4001LY	One-way switch 1P 10 AX 250 Va.c. - White/Ivory
<input type="checkbox"/> BE4003LW <input checked="" type="checkbox"/> BE4003LY	Two-way switch 1P 10 AX 250 Va.c. - White/Ivory
<input type="checkbox"/> BE4004LW <input checked="" type="checkbox"/> BE4004LY	Four-way switch 1P 10 AX 250 Va.c. - White/Ivory
<input type="checkbox"/> BE4403W <input checked="" type="checkbox"/> BE4403Y	Resistive dimmer for incandescent and halogen lamps. 100-500W 230 Va.c. - White/Ivory
<input type="checkbox"/> BE4005LW <input checked="" type="checkbox"/> BE4005LY	Pushbutton 1P (NO) 16A 250 Va.c. - White/Ivory

ITEM	SOCKET OUTLETS
<input type="checkbox"/> BE4122ETW <input checked="" type="checkbox"/> BE4122ETY	Egyptian standard socket 2P 10 A 250 Va.c. - contact tubes Ø 4 - 4.8 mm - centre line of holes 19 mm. White/Ivory
<input type="checkbox"/> BE4125W <input checked="" type="checkbox"/> BE4125Y	Euro american standard socket 2P 16 A 250 /127 Va.C.Ø 5mm
<input type="checkbox"/> BE4140W <input checked="" type="checkbox"/> BE4140Y	German standard socket 2P+E 16 A - 127/250 Va.c. P31 type - with shutters for child protection. White/Ivory
<input type="checkbox"/> BE4180W <input checked="" type="checkbox"/> BE4180Y	Italian standard socket 2P+E 16 A 250 Va.c.- centre distance 19 mm and 26 mm - for plugs 2P and 2P+E 10 and 16 A - with shutters for child protection. White/Ivory
<input type="checkbox"/> BE5285C1W <input checked="" type="checkbox"/> BE5285C1Y	5 Vd.c. USB charger to be used only for recharging electronic devices up to 1500 mA like mobile phones, smartphones, tablets and similar - 230 Va.c. power supply. White/Ivory

TV, RJ11, RJ45 SOCKET

مخارج تلفزيون, تليفون و إنترنت



BE4269FW BE4232RJ11W BE4262C5EW BE5979C6W

BELLS

الأجراس



BE4351V230W

ACCESSORIES

الإكسسورات



BE4950SW

ITEM	TV, RJ11, RJ45 SOCKET
<input type="checkbox"/> BE4269FW <input checked="" type="checkbox"/> BE4269FY	Type F TV female connector 75 Ω impedance Screw coupling 1 module White/Ivory
<input type="checkbox"/> BE4232RJ11W <input checked="" type="checkbox"/> BE4232RJ11Y	RJ 11 telephone sockets 1 module White/Ivory
<input type="checkbox"/> BE4262C5EW <input checked="" type="checkbox"/> BE4262C5EY	RJ 45 data transmission/ telephone sockets - 110IDC cat5E UTP - 1 module White/Ivory
<input type="checkbox"/> BE5979C6W <input checked="" type="checkbox"/> BE5979C6Y	RJ 45 data transmission/ telephone sockets - 110IDC cat6 UTP - 1 module White/Ivory

ITEM	BELLS
<input type="checkbox"/> BE4351V230W <input checked="" type="checkbox"/> BE4351V230Y	Bronze Bell - 230Vac - 12 VA - 80 dB. White/Ivory

ITEM	ACCESSORIES
<input type="checkbox"/> BE4950SW <input checked="" type="checkbox"/> BE4950SY	1-module blanking plate White/Ivory

NOTE

W = references White color  
Y = references Ivory color

TABLE OF CHOICE

Boxes	503EG	Plasterboard boxes	PB503N	Frames	BE4703
N° of modules	3 modules	Plates	D4803M3...		

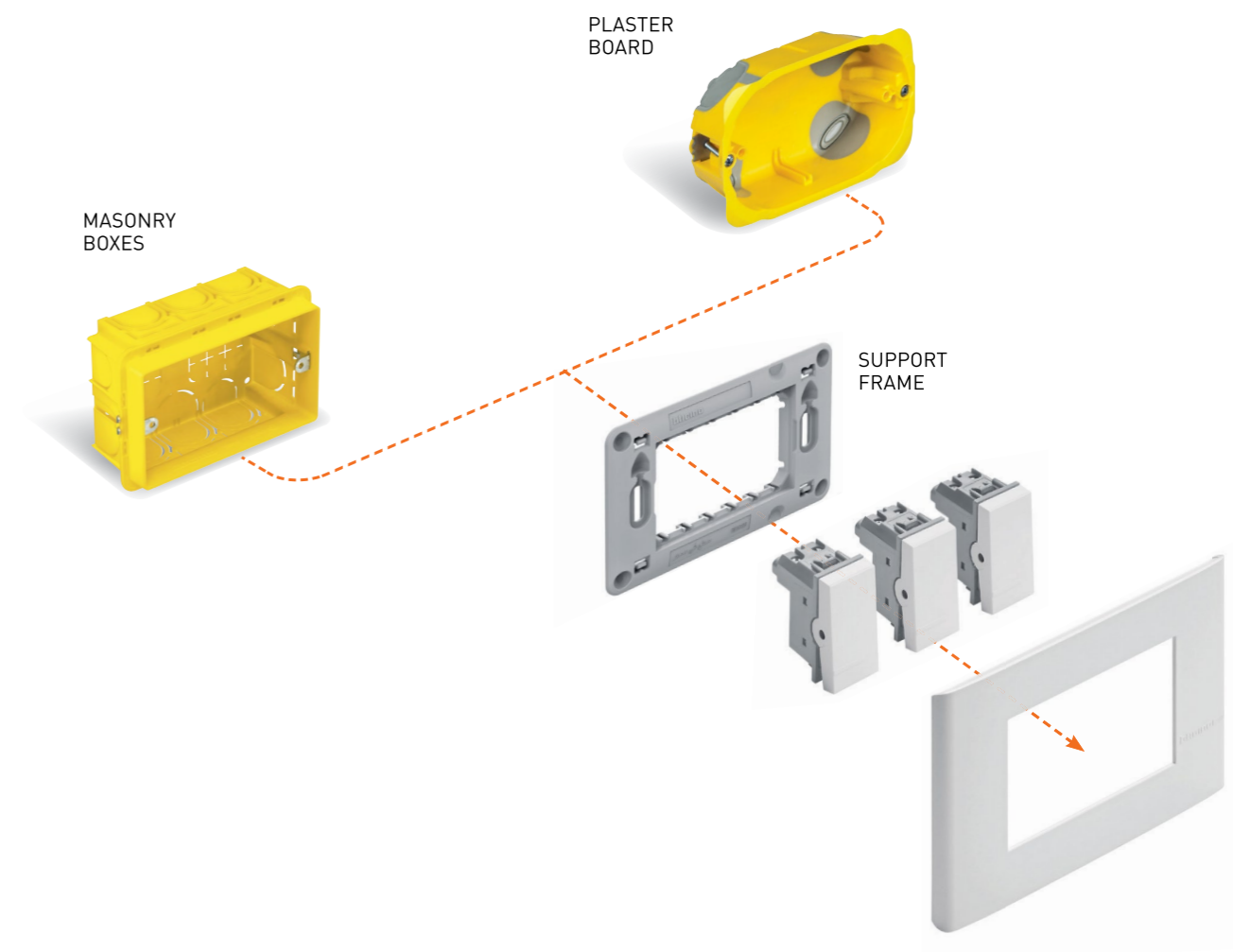

TOTAL LOOK

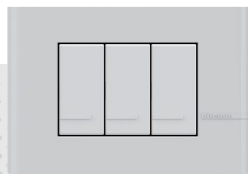

WHITE - BE4803M3BN

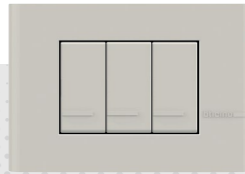

IVORY - BE4803M3AV

COLOR

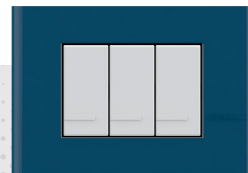

BLUE BE - BE4803M3BE



BLACK BK - BE4803M3BK

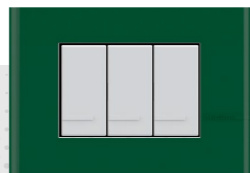

PINE PI - BE4803M3PI

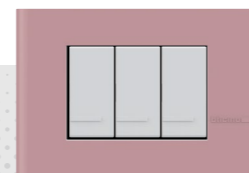

PINK PK - BE4803M3PK

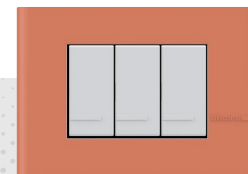

LIGHT AMBER AB - BE4803M3AB

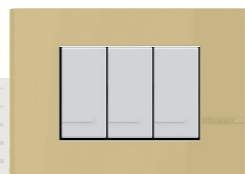

LIGHT YELLOW LY - BE4803M3LY

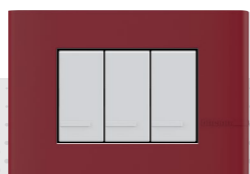

BRIGHT RED RE - BE4803M3RE

METAL EFFECT

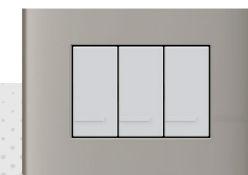

TITANIUM TT - BE4803M3TT

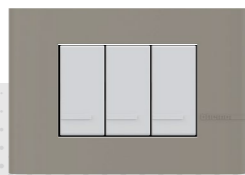

LIGHT BROWN LB - BE4803M3LB

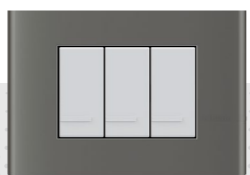

DARK BROWN DB - BE4803M3DB

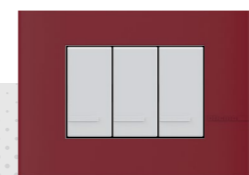

RED RD - BE4803M3RD

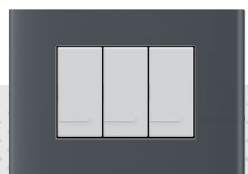

BLUE VIOLET BV - BE4803M3BV

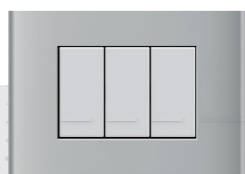

SILVER SL - BE4803M3SL

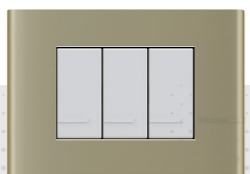

MATT GOLD GL - BE4803M3GL



DURABLE & TIMELESS DESIGN



## MAGIC

### BASIC CONTROL DEVICES مفاتيح التحكم الاساسيه



ITEM	BASIC CONTROL DEVICES
<input type="checkbox"/> 5001E	1 way switch/ (250V a.c.) - 16A 1P
<input type="checkbox"/> 5003E	2 way switch/(250V a.c.) - 16A 1P
<input type="checkbox"/> 5012E	Intermediate swich . 16 A.
<input type="checkbox"/> 5005E	pushbutton/(250V a.c.) - 16A NO 1P
<input type="checkbox"/> 5011*	switch 2P 16 A 250V a.c.
<input type="checkbox"/> 5052N*	1P 16 A 250V a.c. key 1-0-2 double interlock
<input type="checkbox"/> 5006N*	button 1P NO 10 A 250V a.c. - with 1.8m long cord

\* ملحوظة : هذا المنتج متاح عند الطلب

### DIMMER ديمر

ITEM	DIMMER
<input type="checkbox"/> 5361*	rotary dimmer for resistive loads - 100W/500W 230 Va.c.

\* ملحوظة : هذا المنتج متاح عند الطلب

### BELL جرس

ITEM	BELL
<input type="checkbox"/> 5041N	bronze bell - 230va.c. 8 VA.

### SOCKETS مخارج الكهرباء



ITEM	SOCKETS
<input type="checkbox"/> 5022E	10/16A 2P - Distance between centers 19 mm - contacts $\phi$ 4 - 4.8 mm
<input type="checkbox"/> 5180	10/16A 2P+E Distance between centers 19-26 mm - contacts $\phi$ 4.4 - 5.5 mm protected receptacles.
<input type="checkbox"/> 5440/3	10/16A 2P+E Schuko type + central earth - distance between contacts 19 mm - contacts $\phi$ 5.6 mm - protected receptacles.
<input type="checkbox"/> 5025	10/16 A 2p - Euro American Standard

### TV, TELEPHONE AND INTERNET مخارج التلفزيون، التليفون والإنترنت



ITEM	TV JACKS
<input type="checkbox"/> 5152D	shunted coax jack for single- user antenna systems
<input type="checkbox"/> 5152E	shunted sat socket

ITEM	RJ45 CONNECTORS
<input type="checkbox"/> 5979/5E	RJ45 Cat. 5E - UTP - toolless termination - with shutter
<input type="checkbox"/> 5979C6	RJ45 Cat. 6 - UTP - toolless termination - with shutter

ITEM	RJ11 - RJ12 CONNECTORS
<input type="checkbox"/> 5021M/4	RJ11 - 2 pairs
<input type="checkbox"/> 5021M/6	RJ12 - 3 pairs

  

ITEM	FLEX OUTLET
<input type="checkbox"/> 5009N	Flex outlet - $\phi$ 9,5 mm hole

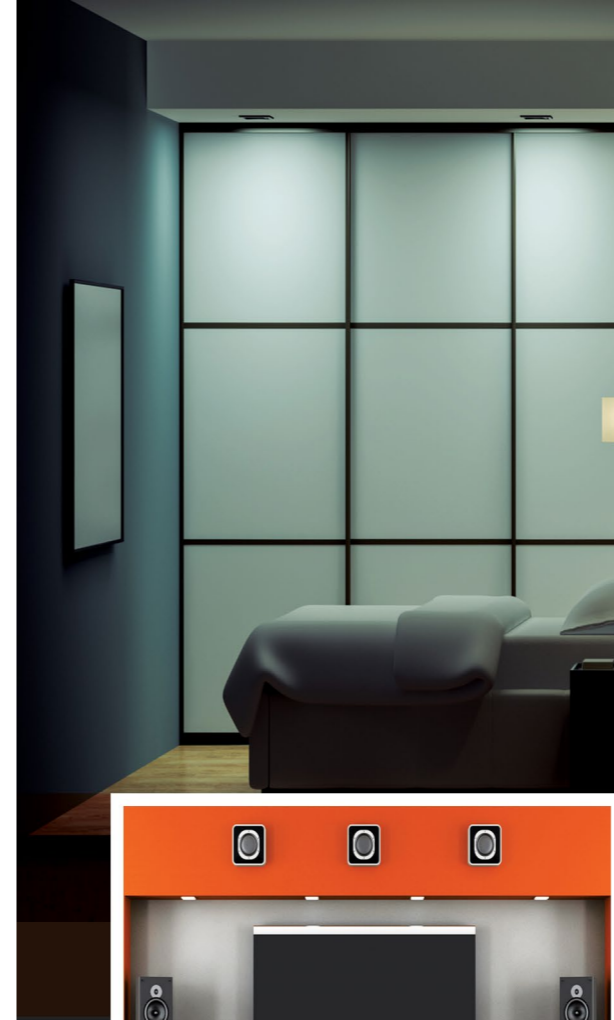

# MCB BT DIN

## THE BEST PROTECTION SOLUTION

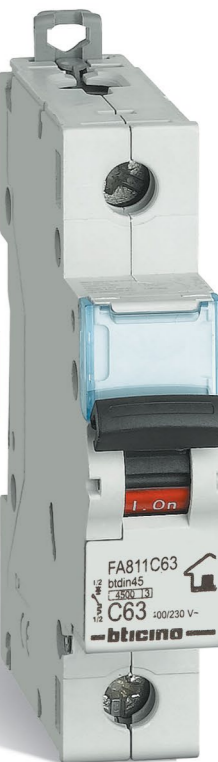



# The new era of modular circuit breakers

Bticino completely redesigned its range of MCBs BT DIN for protection against overcurrent and differential.

The new MCB BT DIN, characterized by the same power interruption for all calibration range, propose technical solutions and innovative features to ensure the highest level of protection in any situation.

## TECHNICAL DATA

THERMAL-MAGNETIC CIRCUIT BREAKERS

- IN = 10 TO 63 A
- 1P, 2P & 3P
- C CURVE
- BREAKING CAPACITY: 4.5 KA, 6 KA AND 10 KA

## COMPLIANCE WITH STANDARDS

BT DIN equipments are manufactured in compliance with specific standards:

	IEC Standard
Thermal-magnetic circuit breakers	IEC 60898-1 / IEC60947

### MINI FLUSH MOUNTING CONSUMER UNIT لوحة 1 أو 2 خط



E213/2



### MINI FLUSH MOUNTING CONSUMER UNIT لوحة لت تركيب عدد 1 أو 2 قاطع أوتوماتيكي حتى 63 أمبير

ITEM	DESCRIPTION
<input type="checkbox"/> E213/2	Mini flush mounted consumer unit 1 pole or 2 poles

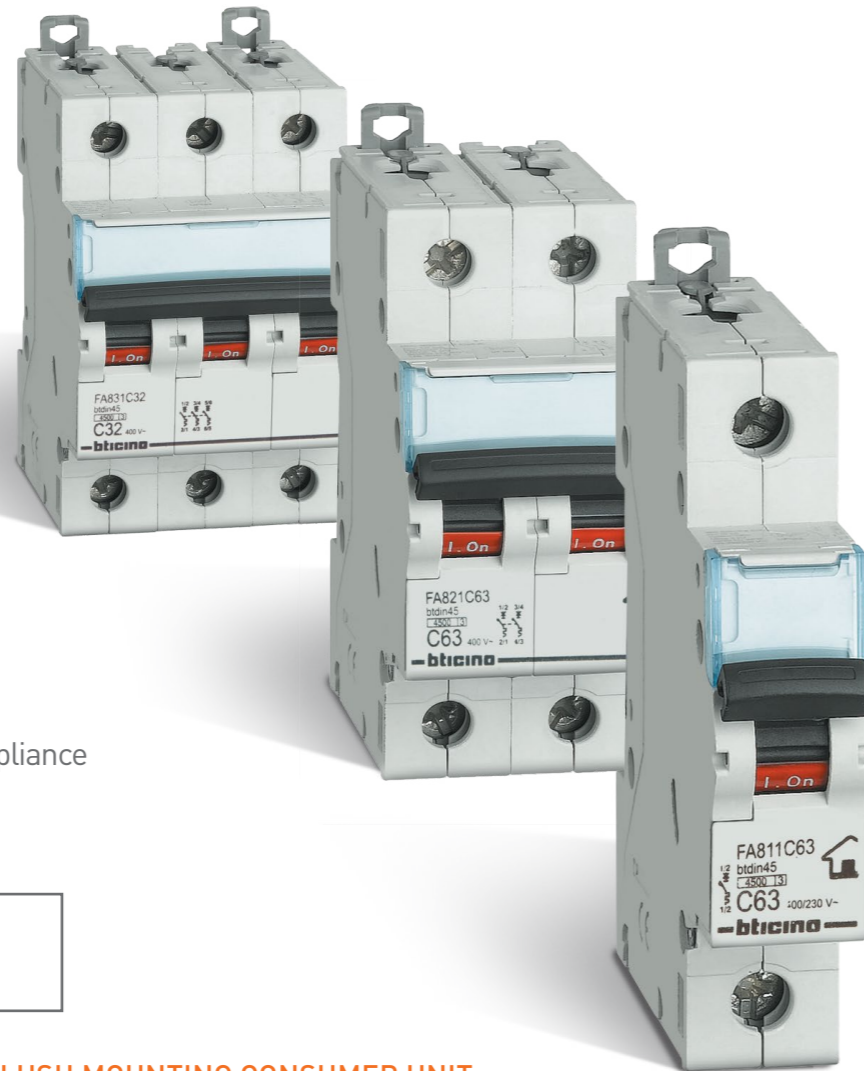

# The NEW MCB's features

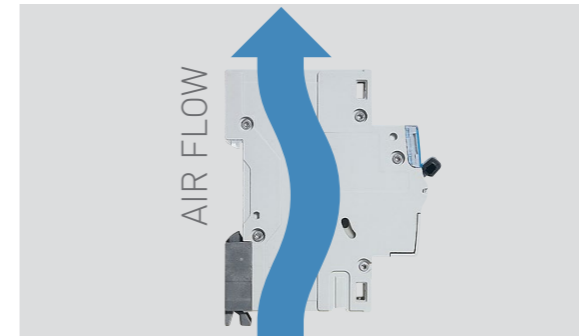

### A PRODUCT DESIGNED WITH SAFETY IN MIND

The product design and materials have been carefully developed to allow air to flow freely between each device to avoid overheating.



### RISING CAGE CLAMP TERMINALS

For high quality, durable connections.



### CLEAR MARKING ON THE FRONT PANEL

For quick visual identification of the relevant information - product name, curve type, rating, breaking capacity, limitation class.



### LIMITATION CLASS 3

Circuit breakers with class 3 limitation provide excellent short-circuit protection. They limit the short-circuit energy released in cables and hence help extend the service life of an installation.



### WIRE GUIDE FLAP

Avoids connection errors for an increased safety level, by preventing insertion of the wire behind the terminal.



### BISTABLE CLIP

For easy positioning or removal of the product on the DIN rail. Compatible with flat-blade or Phillips screwdrivers. Ensures even more comfort during installation.

MCB

# MCB BTDIN 4.5K / 6K / 10K

Safety on all levels

قواطع التيار المنمنمة الجديدة  
حماية حرارية و مغناطيسية

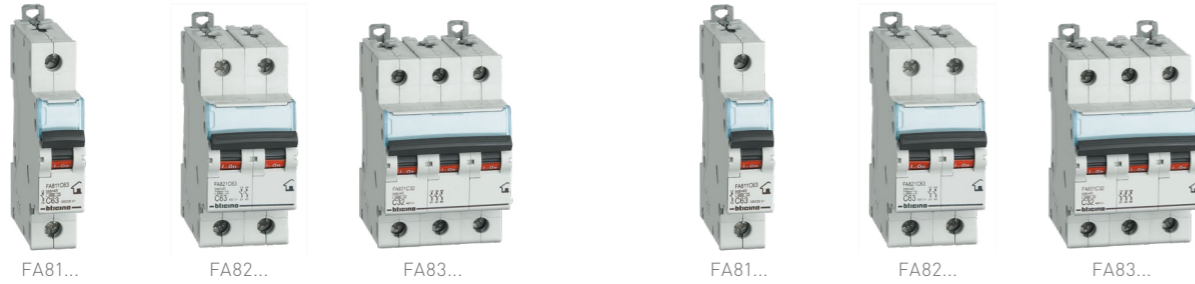

## NEW BTDIN45 THERMAL MAGNETIC 4500 A

1-pole - 230/400 Va.c.

CURVA C	IN (A)	N° OF POLES
FA811C10	10	1
FA811C16	16	1
FA811C20	20	1
FA811C25	25	1
FA811C32	32	1
FA811C40	40	1
FA811C50	50	1
FA811C63	63	1

2-poles - 400 Va.c.

CURVA C	IN (A)	N° OF POLES
FA821C10	10	2
FA821C16	16	2
FA821C20	20	2
FA821C25	25	2
FA821C32	32	2
FA821C40	40	2
FA821C50	50	2
FA821C63	63	2

3-poles - 400 Va.c.

CURVA C	IN (A)	N° OF POLES
FA831C10	10	3
FA831C16	16	3
FA831C20	20	3
FA831C25	25	3
FA831C32	32	3
FA831C40	40	3
FA831C50	50	3
FA831C63	63	3

## NEW BTDIN60 THERMAL MAGNETIC 6000 A

1-pole - 230/400 Va.c.

CURVA C	IN (A)	N° OF POLES
FH810C10	10	1
FN810C16	16	1
FN810C20	20	1
FN810C25	25	1
FN810C32	32	1
FN810C40	40	1
FN810C50	50	1
FN810C63	63	1

2-poles - 400 Va.c.

CURVA C	IN (A)	N° OF POLES
FN820C10	10	2
FN820C16	16	2
FN820C20	20	2
FN820C25	25	2
FN820C32	32	2
FN820C40	40	2
FN820C50	50	2
FN820C63	63	2

3-poles - 400 Va.c.

CURVA C	IN (A)	N° OF POLES
FN830C10	10	3
FN830C16	16	3
FN830C20	20	3
FN830C25	25	3
FN830C32	32	3
FN830C40	40	3
FN830C50	50	3
FN830C63	63	3

## NEW BTDIN10 THERMAL MAGNETIC 10000 A

1-pole - 230/400 Va.c.

CURVA C	IN (A)	N° OF POLES
FH810C10	10	1
FH810C16	16	1
FH810C20	20	1
FH810C25	25	1
FH810C32	32	1
FH810C40	40	1
FH810C50	50	1
FH810C63	63	1

2-poles - 400 Va.c.

CURVA C	IN (A)	N° OF POLES
FH820C10	10	2
FH820C16	16	2
FH820C20	20	2
FH820C25	25	2
FH820C32	32	2
FH820C40	40	2
FH820C50	50	2
FH820C63	63	2

3-poles - 400 Va.c.

CURVA C	IN (A)	N° OF POLES
FH830C10	10	3
FH830C16	16	3
FH830C20	20	3
FH830C25	25	3
FH830C32	32	3
FH830C40	40	3
FH830C50	50	3
FH830C63	63	3



# SAFETY BREAKERS

# SAFETY WITH A MODERN LOOK



NOTE: AX = filament and fluorescent lamp current □ White colour device

**SAFETY BREAKER**  
PROTECTIVE AND DECORATIVE SOLUTION

مفتاح الحماية  
قمة الأمان والشكل العصري

**DISCONNECT SWITCH WITH OVER LOAD PROTECTION**  
مفتاح فصل و حماية من الحمل الزائد



**SAFETY BREAKER IN MATIX COVER PLATE**

مفتاح حماية فى إطار ماتكس

ITEM	DESCRIPTION
<input type="checkbox"/> BSB1/20EM	Flush mounting safety breaker 2P, For Matix Edge cover plates 20A- 220V~ - 1.5KA
<input type="checkbox"/> BSB1/30EM	Flush mounting safety breaker 2P, For Matix Edge cover plates 30A- 220V~ - 1.5KA
<input type="checkbox"/> BSB1/40EM	Flush mounting safety breaker 2P, For Matix Edge cover plates 40A- 220V~ - 1.5KA

**SAFETY BREAKER IN MAGIC ADVANCE COVER PLATE**

مفتاح حماية فى إطار ماجيك ادفانس

ITEM	DESCRIPTION
<input type="checkbox"/> BSB1/20EA	Flush mounting safety breaker 2P, Supplied with Magic Advance cover plate 20A- 220V~ - 1.5KA
<input type="checkbox"/> BSB1/30EA	Flush mounting safety breaker 2P, Supplied with Magic Advance cover plate 30A- 220V~ - 1.5KA
<input type="checkbox"/> BSB1/40EA	Flush mounting safety breaker 2P, Supplied with Magic Advance cover plate 40A- 220V~ - 1.5KA

**SAFETY BREAKER IN MATIX & SOLIDA COVER PLATE**

مفتاح حماية فى إطار ماتكس إيدج و سوليدا



CODES	DESCRIPTION
BSB1/30ESO	Flush mounting safety breaker 1P+N for Solida cover plates, 30A- 230V- 2.5KA (White Cover Plate Included) - New
BSB1/30EMEC	Flush mounting safety breaker 1P+N for Matix Edge cover plates, 30A- 230V- 2.5KA (White Cover Plate Included) - New

**SURFACE MOUNTED SAFETY BREAKER**

مفتاح حماية خارج الحائط



**SAFETY BREAKER IN PLASTIC BACK BOX**  
مفتاح حماية فى علبة بلاستيك

ITEM	DESCRIPTION
<input type="checkbox"/> BSB1/20ES	Surface mounting safety breaker 20A - 220V~ - 1.5KA
<input type="checkbox"/> BSB1/30ES	Surface mounting safety breaker 30A - 220V~ - 1.5KA
<input type="checkbox"/> BSB1/40ES	Surface mounting safety breaker 40A - 220V~ - 1.5KA

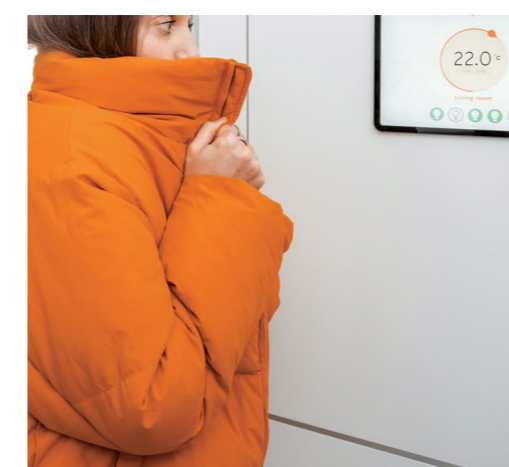

**FUSE SWITCH**

**THE ESSENTIAL POWER SWITCH**



## FUSE SWITCH

FUSE SWITCH  
EXTREME PROTECTION FOR APPLIANCES

مفتاح الفصل والتوصيل  
أقصى حماية للأجهزة الكهربائية

### SURFACE-MOUNTING FUSED CIRCUIT BREAKERS مفاتيح مجهزة بالمصهرات للتركيب السطحي (خارج الحائط)



ITEM	DESCRIPTION
<input type="checkbox"/> 601	breaker 380V a.c. - with 26A fuses - ceramic body and moulded ivory top - with spare fuse holder
<input type="checkbox"/> 602	single-pole
<input type="checkbox"/> 603	two-pole
<input type="checkbox"/> 603	three-pole

ITEM	DESCRIPTION
<input type="checkbox"/> 602NU	breaker 380V a.c. - with 32A fuses - ceramic body and moulded ivory top - with spare fuse holder
<input type="checkbox"/> 603NU	two-pole
<input type="checkbox"/> 603NU	three-pole

### FLUSH-MOUNTING FUSED CIRCUIT BREAKERS

مفاتيح مجهزة بالمصهرات  
للتثبيت داخل الحائط



ITEM	DESCRIPTION
<input type="checkbox"/> 642M	breaker 380V a.c. - with 26A and 32A fuses - ceramic body and moulded ivory top - with spare fuse holder
<input type="checkbox"/> 642NUM	26A two-pole
<input type="checkbox"/> 642NUM	32A two-pole

ITEM	DESCRIPTION
<input type="checkbox"/> 643	breaker 380V a.c. - with 26A and 32A fuses - ceramic body and moulded ivory top - with spare fuse holder
<input type="checkbox"/> 643NU	26A three-pole
<input type="checkbox"/> 643NU	32A three-pole

### FLUSH-MOUNTING BOX FOR FUSED CIRCUIT BREAKERS

علبة داخل الحائط لتثبيت المفاتيح  
المجّهزة بالمصهرات



642YB  
(121x61x46 mm)

ITEM	DESCRIPTION
<input type="checkbox"/> 642YB	plastic rectangular box for fuse switch

FUSE SWITCH IS COMPLYING  
WITH SPECIFIC STANDARDS: IEC Standard

Fuse Switch	IEC 62080
-------------	-----------



COMPLIMENTARY PRODUCTS

# NECESSARY SOLUTIONS









## **EMB Electrical Industries S.A.E.**

### **Headquarter office**

Pyramids Heights Office Park  
KM 22 Cairo - Alex. desert road  
Building 9C, 12556  
Tel.: +202 3536 0000  
Fax: +202 3536 0001  
[www.bticino.com.eg](http://www.bticino.com.eg)

FOLLOW US ON



[www.bticino.com.eg](http://www.bticino.com.eg)



[facebook.com/bticinoEgypt](https://facebook.com/bticinoEgypt)



[instagram.com/bticinoEgypt](https://instagram.com/bticinoEgypt)

**bticino**